



**Technical Data**  
**Caractéristiques techniques**

# LTM 1200/1

**Mobile Crane**  
**Grue automotrice**

Telescopic boom  
Flèche télescopique

**197 ft**

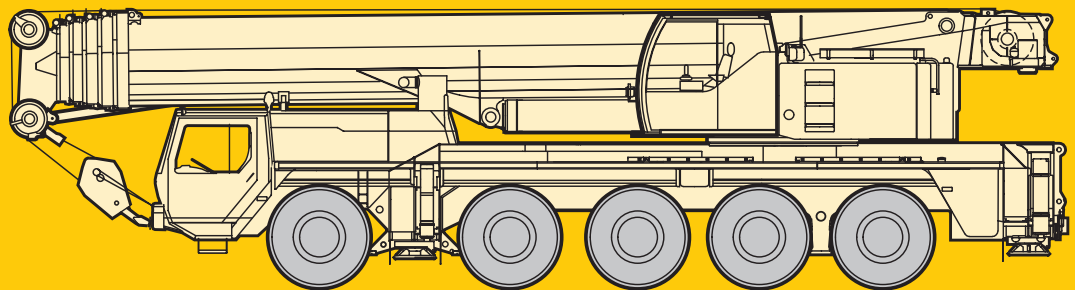

# LIEBHERR



# Lifting capacities on telescopic boom. Forces de levage à la flèche télescopique.

LTM 1200/1



44 ft - 197 ft



360°



152100 lbs

85%

ft	44 ft		58 ft	72 ft	86 ft	100 ft	114 ft	128 ft	142 ft	156 ft	171 ft	185 ft	197 ft	ft
	1)													
10	471	337												10
11	379	322	285											11
12	329	307	284											12
13	318	293	282	276	223									13
14	302	280	274	272	221	177								14
15	287	268	265	265	218	177								15
16	277	257	256	255	215	176	142							16
17	267	247	247	246	213	173	141							17
18	258	237	238	237	211	170	140							18
20	239	219	220	219	206	163	137	115						20
22	223	204	204	204	198	156	138	114	92					22
24	208	190	190	190	188	154	138	111	91.5					24
26	195	176	177	177	176	155	136	108	91	75				26
28	182	165	165	165	164	155	135	105	89	74.5	60.5			28
30	169	154	155	155	153	153	134	102	86.5	74	60.5			30
32	153	145	146	145	144	145	132	98.5	84.5	73	60.5	48.5		32
34			138	137	135	137	129	95.5	82.5	72	59.8	48.3		34
36			130	128	127	129	126	91.5	80.5	71	59.2	48.1	40	36
38			123	121	120	123	122	88	78.5	69	58.7	47.6	40	38
40			117	115	114	118	117	85	76.5	67	58.1	47.2	39.8	40
45			102	101	99.5	104	103	77.5	70.5	63	55.5	46.2	38.7	45
50				89	90.5	93	91.5	71	65	58.8	52.7	44.8	37.5	50
55				79	83	83	81.5	66	59.8	54.7	49.7	43.4	36.3	55
60					75.5	74.5	73	61	55.2	51	46.5	41.8	35.2	60
65					68.5	67.5	66	57.1	50.9	47.6	43.7	39.7	34.1	65
70					62.5	61.5	59.9	53.9	47.4	44.3	41	37.8	33.1	70
75						56.1	54.5	51.2	44.2	41.4	38.6	35.9	32.1	75
80						51.4	49.8	48.7	41.6	38.8	36.3	34.1	31.1	80
85						47.2	45.6	46.4	39.2	36.4	34.2	32.3	29.5	85
90							42	43.3	36.9	34.1	32.2	30.6	28	90
95							38.7	40.2	34.8	31.9	30.3	28.9	26.6	95
100							34.7	37.2	32.9	29.9	28.5	27.4	25.2	100
105								34.4	31.4	28.2	26.9	25.9	23.9	105
110								32	30	27	25.4	24.7	22.7	110
115								28.8	28.7	25.9	23.9	23.5	21.5	115
120									27.6	24.8	22.7	22.3	20.5	120
125									26.5	23.7	21.6	21.2	19.4	125
130									24.5	22.7	20.8	20	18.4	130
135										21.6	20	18.9	17.4	135
140										20.9	19.2	18	16.5	140
145											18.5	17.1	15.6	145
150											17.8	16.3	14.8	150
155											17.1	15.5	14.1	155
160												14.7	13.4	160
165												13.9	12.8	165
170												13	12.1	170
175													11.5	175
180													10.9	180
I	0	0/ 0/ 0	0/ 0/ 0	0/ 0/ 0	46/ 0/ 0	46/46/ 0	92/46/ 0	92/46/46	92/46/46	92/46/46	92/46	92	100	I
II	0	0/ 0/ 0	46/ 0/ 0	46/92/ 0	46/46/46	46/46/92	46/92/46	92/92/46	92/92/46	92/92/46	92/92	92	100	II
III	0	46/ 0/ 0	46/ 0/ 0	46/46/46	46/46/46	46/46/46	46/46/46	46/92/46	92/92/92	92/92/92	92/92	92	100	III
IV	0	0/46/ 0	0/46/ 0	0/ 0/46	0/46/46	46/46/46	46/46/46	46/46/92	46/46/92	46/92/92	92/92	92	100	IV
V	0	0/ 0/46	0/46/92	0/ 0/46	0/ 0/46	0/46/46	46/46/92	46/46/92	46/46/92	46/46/92	46/92	92	100	V

1) over rear / en arrière

TAB 133018 / 133019

## Remarks referring to load charts.

- The tabulated lifting capacities do not exceed 85% of the tipping load.
- The crane's structural steelwork is in accordance with DIN 15018, part 3.  
Design and construction of the crane comply with DIN 15018, part 2, and with F.E.M. regulations.
- The 85% overturning limit values take into account wind force 5 = wind speed 20 mph.
- Lifting capacities are given in kips.
- The weight of the hook blocks and hooks must be deducted from the lifting capacities.
- Working radii are measured from the slewing centreline.
- The lifting capacities given for the telescopic boom only apply if the folding jib is taken off.
- Lifting capacities are subject to modifications.
- Lifting capacities above 326/357 kips only with additional pulley block/special equipment.

# Lifting capacities are given in kips (1,000 lbs).

2



# Lifting capacities on telescopic boom. Forces de levage à la flèche télescopique.

LTM 1200/1



44 ft - 197 ft



360°



99200 lbs

85%

ft	44 ft	58 ft	72 ft	86 ft	100 ft	114 ft	128 ft	142 ft	156 ft	171 ft	185 ft	197 ft	ft
10	336												10
11	319	285											11
12	304	284											12
13	289	282	276	223									13
14	277	274	271	221	177								14
15	264	264	264	218	177								15
16	253	253	253	215	176	142							16
17	242	243	242	213	173	141							17
18	232	232	232	211	170	140							18
20	212	213	212	205	163	137	115						20
22	195	196	196	193	156	138	114	92					22
24	180	181	180	179	154	138	111	91.5					24
26	166	167	166	165	155	136	108	91	75				26
28	154	156	154	153	147	135	105	89	74.5	60.5			28
30	143	145	143	141	139	132	102	86.5	74	60.5			30
32	133	135	133	129	130	123	98.5	84.5	73	60.5	48.5		32
34		127	125	124	122	115	95.5	82.5	72	59.8	48.3		34
36		118	116	119	113	106	91.5	80.5	71	59.2	48.1	40	36
38		111	108	111	105	99.5	88	78.5	69	58.7	47.6	40	38
40		104	102	104	98.5	93	84.5	76.5	67	58.1	47.2	39.8	40
45		90.5	91.5	89	85	80	76.5	70.5	63	55.5	46.2	38.7	45
50			79.5	78	74	70	68	63	58.8	52.7	44.8	37.5	50
55			69	68.5	65	61.5	62	57	54.1	49.7	43.4	36.3	55
60				60.5	57.9	56.8	54.9	51.7	49	46.5	41.8	35.2	60
65				53.3	51.9	52.1	49.3	46.7	44.8	43.4	39.7	34.1	65
70				47.7	46.6	47.3	44.5	43.8	41.4	39.3	37.8	33.1	70
75					41.9	43.1	40.4	40.4	37.8	36.1	35.5	32.1	75
80					38	39.3	37.3	36.8	35.2	34	32.9	31	80
85					34.4	35.6	34.7	33.7	32.9	31.7	30	29.4	85
90						32.5	32.8	31	30.3	29.1	27.4	27	90
95						29.8	30.4	28.6	27.9	26.8	25.1	24.7	95
100						27.3	27.9	26.9	25.9	24.7	23	22.6	100
105							25.6	25.7	24.1	22.7	21.1	20.8	105
110							23.6	23.6	22.4	21	19.4	19.1	110
115							21.9	21.8	20.7	19.5	17.9	17.6	115
120								20.1	19	18	16.5	16.2	120
125								18.6	17.4	16.6	15.1	14.9	125
130								17.2	16.1	15.2	13.9	13.7	130
135									14.8	14	12.8	12.6	135
140									13.7	12.8	11.6	11.5	140
145										11.7	10.5	10.5	145
150										10.7	9.5	9.5	150
155										9.8	8.5	8.6	155
160											7.7	7.7	160
165											6.9	6.9	165
170											6.1	6.1	170
175												5.4	175
180												4.8	180
I	0	0/ 0/ 0	0/ 0/ 0	46/ 0/ 0	46/ 0/ 0	92/46/ 0	92/46/ 0	92/46/ 0	92/46/ 0	92/46	92	100	I
II	0	0/ 0/ 0	46/ 0/ 0	46/92/ 0	92/46/ 0	46/46/46	46/46/46	92/46/46	92/92/92	92/92	92	100	II
III	0	46/ 0/ 0	46/ 0/ 0	46/46/46	46/46/92	46/46/46	46/46/46	46/46/92	92/92/92	92/92	92	100	III
IV	0	0/46/ 0	0/46/ 0	0/ 0/46	0/46/46	46/46/46	46/46/92	46/92/92	46/92/92	92/92	92	100	IV
V	0	0/ 0/46	0/46/92	0/ 0/46	0/46/46	0/46/92	46/92/92	46/92/92	46/46/92	46/92	92	100	V

TAB 133020

## Remarques relatives aux tableaux des charges.

- Les forces de levage indiquées ne dépassent pas 85% de la charge de basculement.
- La norme DIN 15018, 3ème partie est appliquée pour les charpentes.
- La construction de la grue est réalisée conformément à la norme DIN 15018, 2ème partie, et aux règles de la F. E. M.
- A 85% de la charge de basculement, il a été tenu compte d'un vent de force 5 = vitesse de vent 20 mph.
- Les forces de levage sont données en kips.
- Le poids des mouffes et crochets doit être soustrait des charges indiquées.
- Les portées sont calculées à partir de l'axe de rotation.
- Les forces indiquées pour la flèche télescopique s'entendent fléchette dépliée déposée.
- Les forces de levage sont modifiables sans préavis.
- Forces de levage plus de 326/357 kips seulement avec mouffe additionnel/équipement supplémentaire.



# Lifting heights. Hauteurs de levage.

LTM 1200/1

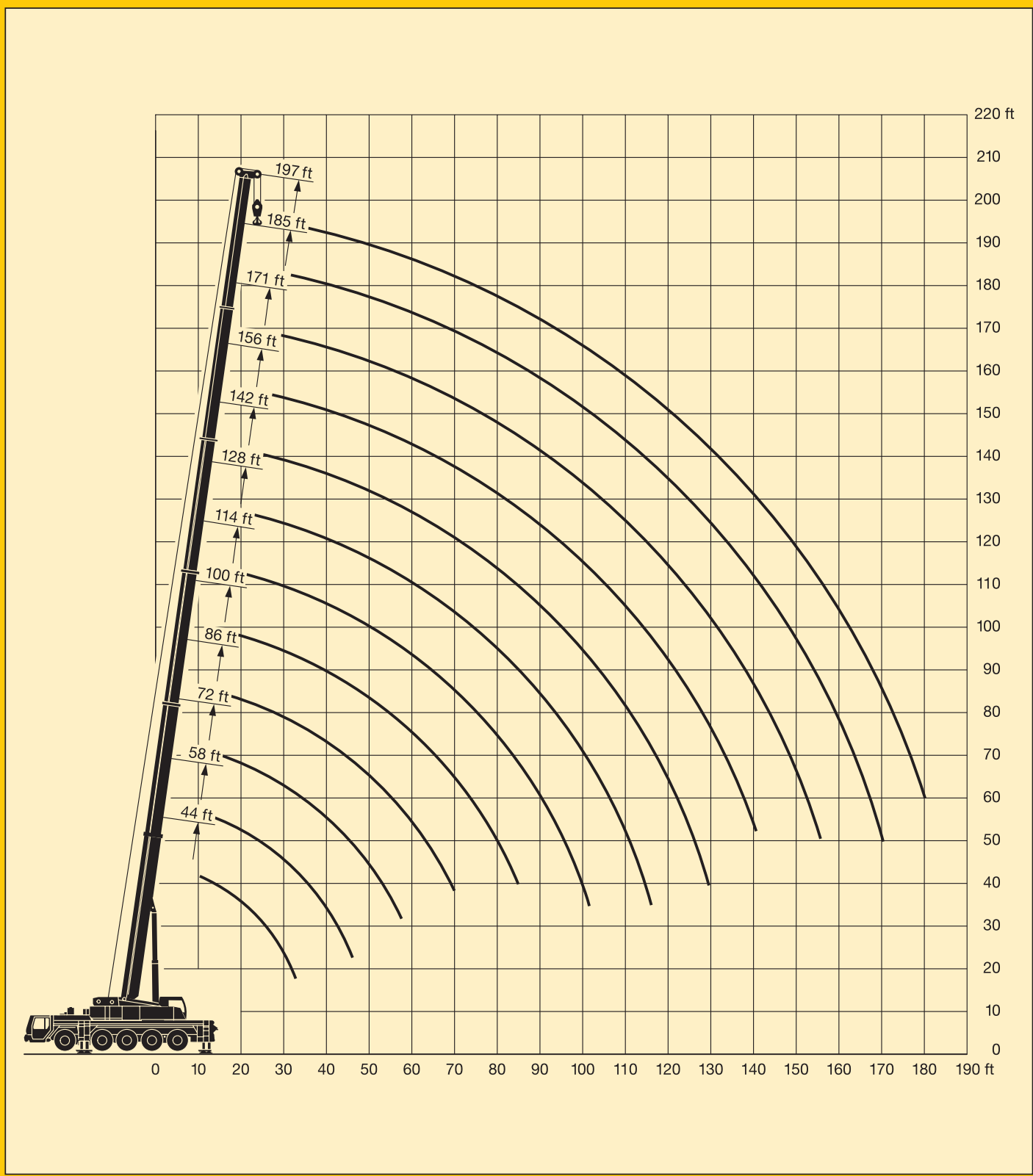



# Lifting capacities on the folding jib. Forces de levage à la fléchette pliante.

LTM 1200/1



44 ft – 197 ft

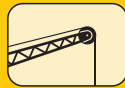

40 ft\*



360°

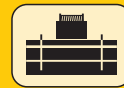

152100 lbs

85%

ft	44 ft			142 ft			156 ft			171 ft			185 ft			197 ft			ft
	0°	20°	40°	0°	20°	40°	0°	20°	40°	0°	20°	40°	0°	20°	40°	0°	20°	40°	
11	42.4																		11
12	42.2																		12
13	41.8																		13
14	41.3																		14
15	40.8																		15
16	40.2																		16
17	39.8																		17
18	39.5																		18
20	38.9	33.7																	20
22	38.1	32.4																	22
24	37.4	31.2																	24
26	36.7	30.1		42.4															26
28	35.4	29.2	23.6	42.3			37.9												28
30	33.9	28.2	23.5	42.1			37.9												30
32	32.3	27.4	23	41.8			37.7		32.4										32
34	30.8	26.6	22.6	41.6			37.6		32.4										34
36	29.4	25.9	22.1	41.3			37.4		32.3										36
38	28.1	25.2	21.8	41			37.2		32.2			26.7				21.8			38
40	26.8	24.6	21.4	40.6			37.1		32.1			26.6				21.8			40
45	24.1	23.2	20.7	39.8	31.5		36.4	31.4	31.8			26.3				21.7			45
50	21.6	22.1	20.1	39.2	30.5	23.1	35.9	30.5	31.4	29.2		25.7				21.6			50
55	19.5	20.8	19.8	38.4	29.4	22.8	35.4	29.4	31	28.7		25.3				21.5			55
60	17.7	19.2	19.5	37.5	28.3	22.4	34.9	28.4	22.3	30.7	27.9	21.8	24.9	24.9		21.3	20.8		60
65	16	17.2	18.2	36.7	27.4	21.9	34.3	27.5	21.9	30.4	27	21.6	24.5	24.5	20.6	20.7	20.4		65
70	14.4	15.3	15.7	35.3	26.5	21.6	33.7	26.7	21.6	29.6	26.3	21.3	24.2	24.1	20.6	20.1	20	19.4	70
75				33.5	25.8	21.2	32.6	26	21.2	28.6	25.6	21	23.7	23.4	20.5	19.6	19.6	19.4	75
80				31.7	25.1	20.9	31.2	25.3	20.9	27.4	25	20.7	23.1	22.7	20.3	19.1	19.1	19.3	80
85				30.1	24.4	20.7	29.6	24.6	20.7	26.3	24.4	20.4	22.4	21.9	20	18.7	18.7	19	85
90				28.5	23.8	20.4	28	24	20.4	25.2	23.9	20.2	21.7	21.1	19.9	18.3	18.2	18.6	90
95				27	23.2	20.2	26.6	23.5	20.2	24.1	23.4	20	20.9	20.4	19.7	17.8	17.7	18.1	95
100				25.7	22.6	20	25.2	23	20	23	22.8	19.9	20.2	19.8	19.5	17.3	17.2	17.6	100
105				24.5	22.2	19.8	23.8	22.5	19.8	22	22.1	19.7	19.4	19.1	19.1	16.8	16.7	17.1	105
110				23.3	21.8	19.7	22.7	22.1	19.7	20.9	21.2	19.6	18.7	18.4	18.4	16.4	16.3	16.6	110
115				22.1	21.4	19.6	21.6	21.5	19.5	19.9	20.3	19.5	18.1	17.8	17.8	15.9	15.9	16.2	115
120				21	20.9	19.5	20.4	20.8	19.3	19	19.4	19.3	17.4	17.2	17.2	15.5	15.5	15.7	120
125				20	20.1	19.4	19.4	19.8	19.2	18	18.4	18.8	16.7	16.6	16.7	15.1	15.1	15.2	125
130				19.2	19.2	19.3	18.3	18.8	19	17.1	17.5	18	16	16.1	16.1	14.5	14.6	14.7	130
135				18.4	18.4	18.7	17.3	17.8	18.4	16.3	16.6	17.2	15.3	15.5	15.6	13.9	14.1	14.3	135
140				17.7	17.6	17.9	16.3	16.9	17.5	15.5	15.8	16.4	14.6	15	15.1	13.2	13.6	13.8	140
145				17	16.8	17.2	15.4	15.9	16.5	14.6	15	15.5	13.9	14.4	14.7	12.6	13	13.3	145
150				16.2	16.1	16.5	14.6	15	15.6	13.8	14.3	14.7	13.2	13.7	14.1	12	12.4	12.8	150
155				15.4	15.4	15.7	13.9	14.2	14.7	13.1	13.6	14.1	12.5	13.1	13.5	11.4	11.8	12.2	155
160				14.6	14.6		13.3	13.5	13.9	12.5	12.9	13.4	12	12.5	12.8	10.8	11.2	11.6	160
165				13.7	13.9		12.8	13	13.1	11.8	12.2	12.7	11.5	11.9	12.2	10.3	10.7	11	165
170				12.2	13.2		12.3	12.4	12.5	11.3	11.5	12	10.9	11.4	11.6	9.7	10.1	10.4	170
175							11.8	11.9		10.8	11	11.3	10.4	10.8	11.1	9.2	9.6	9.9	175
180							11.2	11.4		10.4	10.5	10.7	9.9	10.3	10.5	8.7	9.1	9.4	180
185										10	10.1		9.4	9.8	10	8.3	8.7	8.8	185
190										9.6	9.7		8.9	9.3	9.4	7.9	8.2	8.3	190
195													8.4	8.7	8.8	7.4	7.7	7.8	195
200													7.8	8.2	8.2	7	7.3	7.3	200
205													7.1			6.5	6.8	6.8	205
210																5.8	6.1		210
215																5.4	5.6		215
I	0			46/ 0			92/46/ 0			92/46			92			100			I
II	0			92/46			92/92/92			92/92			92			100			II
III	0			92/92			92/92/92			92/92			92			100			III
IV	0			46/92			46/92/92			92/92			92			100			IV
V	0			46/92			46/46/92			46/92			92			100			V

\* one-parted folding jib / fléchette pliante à 1 élément

TAB 133021 / 133022 / 133023



44 ft - 197 ft

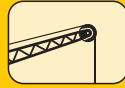

72 ft\*



360°

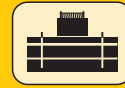

152100 lbs

85%

ft	44 ft			142 ft			156 ft			171 ft			185 ft			197 ft			ft
	0°	20°	40°	0°	20°	40°	0°	20°	40°	0°	20°	40°	0°	20°	40°	0°	20°	40°	
13	18.2																		13
14	18.1																		14
15	18																		15
16	17.9																		16
17	17.9																		17
18	17.8																		18
20	17.7																		20
22	17.5																		22
24	17.4																		24
26	17.2																		26
28	16.9				18.2														28
30	16.7				18.2														30
32	16.5				18.1			17											32
34	16.3				18.1			17											34
36	16.1	15.4			18			17											36
38	15.9	15.1			17.9			16.9		15.7									38
40	15.7	14.9			17.8			16.9		15.7									40
45	15.2	14.2			17.6			16.6		15.5			13.8			12.6			45
50	14.6	13.6			17.4			16.5		15.3			13.8			12.6			50
55	14.1	13			17.2			16.3		15.2			13.7			12.6			55
60	13.5	12.5	11.3		16.9	14.6		16.2		15.1			13.6			12.5			60
65	12.9	12	10.8		16.6	14.6		16	14.3	14.9	13.6		13.5			12.4			65
70	12.5	11.6	10.4		16.3	14.3		15.9	14	14.7	13.4		13.4	12.4		12.4			70
75	12.1	11.3	10.1		16	14		15.7	13.7	14.6	13.2		13.3	12.3		12.2			75
80	11.8	10.9	9.8		15.8	13.6	11.4		15.4	13.4	12.1		13.1	12.3		12.2	11.6		80
85	11.4	10.5	9.6		15.5	13.3	11.3		15.1	13.2	11.2		13.1	12.1		12.1	11.5		85
90	11.1	10.2	9.3		15.2	13.1	11.1		14.9	12.9	11.1		12.9	11.9	10.5	12	11.4		90
95	10.6	9.9	9.2		14.9	12.8	10.8		14.6	12.7	10.9		12.8	11.9	10.4	11.9	11.2		95
100	10.1	9.7			14.6	12.5	10.6		14.3	12.4	10.7		12.7	11.5	10.4	11.8	11.1	9.9	100
105					14.3	12.3	10.4		14	12.2	10.5		12.6	11.4	10.3	11.8	11	9.9	105
110					14	12	10.3		13.8	12	10.3		12.5	11.2	10.2	11.7	10.8	9.9	110
115					13.7	11.8	10.1		13.6	11.8	10.2		13.1	11.5	10.2	12.4	11.1	10.1	115
120					13.4	11.6	10		13.3	11.6	10.1		13	11.4	10.1	12.2	10.9	9.9	120
125					13.1	11.5	9.9		13.1	11.4	9.9		12.7	11.2	9.9	12.1	10.8	9.8	125
130					12.8	11.3	9.7		12.8	11.2	9.8		12.5	11	9.8	11.9	10.7	9.7	130
135					12.6	11.1	9.6		12.6	11.1	9.7		12.3	10.9	9.7	11.7	10.6	9.6	135
140					12.4	11	9.5		12.4	11	9.6		12.1	10.8	9.6	11.6	10.5	9.5	140
145					12.1	10.8	9.4		12.2	10.9	9.4		11.9	10.6	9.5	11.4	10.4	9.4	145
150					11.9	10.5	9.2		12	10.7	9.3		11.7	10.6	9.4	11.2	10.3	9.3	150
155					11.8	10.4	9.2		11.8	10.6	9.2		11.6	10.5	9.3	10.8	10.3	9.3	155
160					11.6	10.2	9.2		11.6	10.4	9.2		11.4	10.5	9.2	10.5	10.2	9.2	160
165					11.4	10.1	9.2		11.4	10.3	9.2		11.1	10.4	9.2	10.2	10.1	9.2	165
170					11.2	9.9	9.2		11.2	10.2	9.2		10.6	10.2	9.2	9.9	9.9	9.2	170
175					11	9.8	9.2		10.9	10	9.2		10.1	10.1	9.2	9.5	9.7	9.2	175
180					10.8	9.7	9.2		10.4	9.9	9.2		9.7	9.9	9.2	9.1	9.4	9.2	180
185					10.5	9.7	9.2		9.9	9.8	9.2		9.2	9.8	9.2	8.7	9.1	9.2	185
190					10.3	9.7	9.2		9.4	9.7	9.2		8.8	9.3	9.2	8.3	8.8	9.2	190
195					10	9.7			9	9.4	9.2		8.4	8.9	9.1	7.9	8.4	8.9	195
200					7.1				8.4	8.9	8.9		8	8.5	8.7	7.6	8.1	8.5	200
205									8.1	8.3			7.6	8	8.2	7.3	7.7	8	205
210													7.2	7.6	7.7	7	7.3	7.6	210
215													6.8	7	7.2	6.2	7	7.2	215
220													6.6	6.7		5.7	6.4	6.6	220
225																5.3	5.8	5.9	225
230																5	5.3		230
235																4.6	4.9		235
240																		3.9	240
245																		3.6	245
I	0				46/ 0				92/46/ 0				92/46			92			I
II	0				92/46				92/92/92				92/92			92			II
III	0				92/92				92/92/92				92/92			92			III
IV	0				46/92				46/92/92				92/92			92			IV
V	0				46/92				46/46/92				46/92			92			V

\* bi-parted folding jib / fléchette pliante à 2 éléments

TAB 133021 / 133022 / 133023

# Les forces de levage sont données en kips (1,000 lbs).



# Lifting heights. Hauteurs de levage.

LTM 1200/1

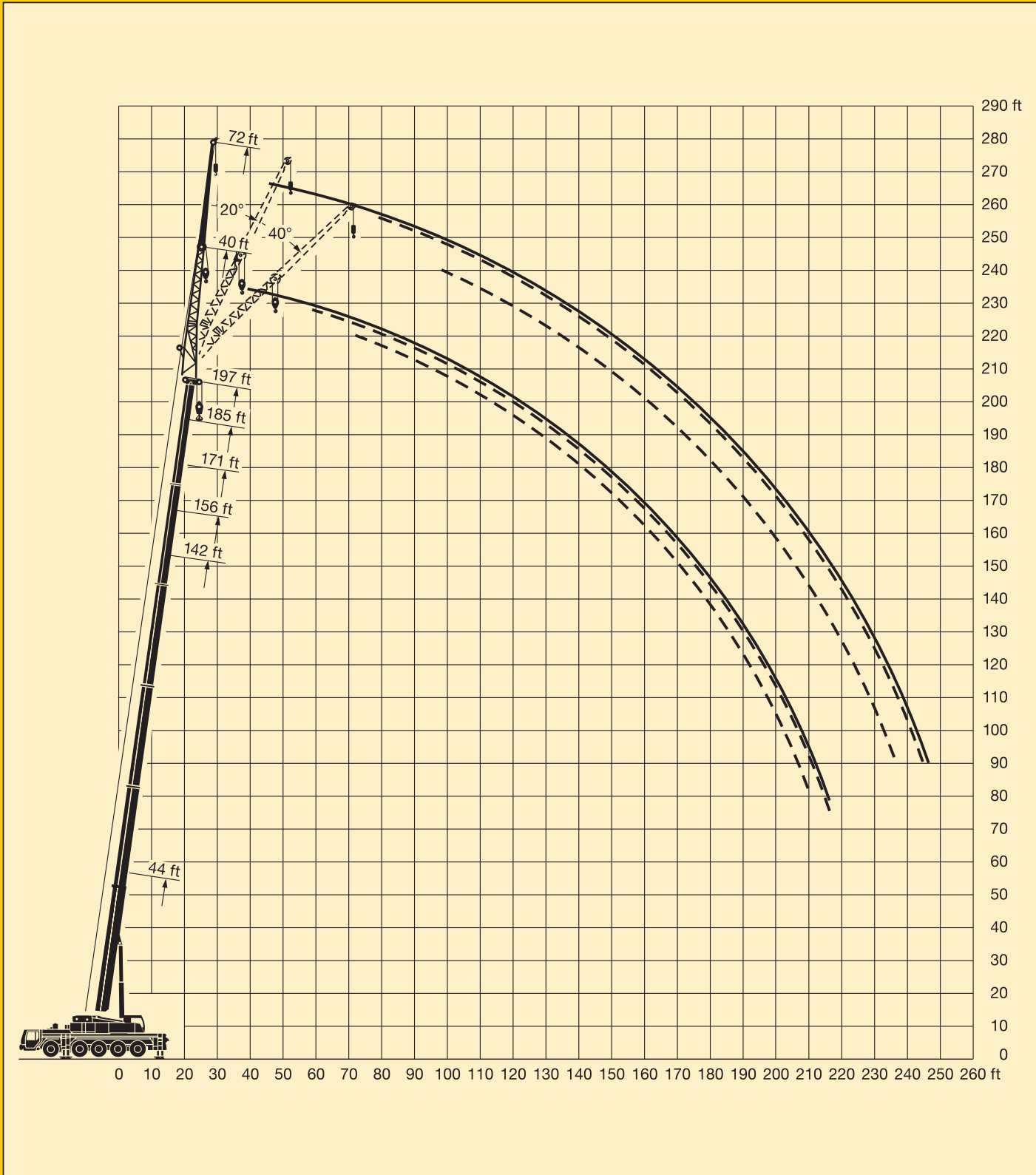



# Lifting capacities on the folding jib. Forces de levage à la fléchette pliante.

LTM 1200/1



44 ft – 197 ft

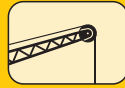

95 ft\*



360°

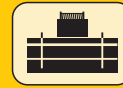

152100 lbs

85%

ft	44 ft			142 ft			156 ft			171 ft			185 ft			197 ft			ft
	0°	20°	40°	0°	20°	40°	0°	20°	40°	0°	20°	40°	0°	20°	40°	0°	20°	40°	
14	13.6																		14
15	13.6																		15
16	13.6																		16
17	13.6																		17
18	13.6																		18
20	13.5																		20
22	13.4																		22
24	13.3																		24
26	13.3																		26
28	13.2																		28
30	13.1																		30
32	13																		32
34	12.9																		34
36	12.8				13.1														36
38	12.6				13.1			12.1											38
40	12.4				13.1			12.1											40
45	11.8				13.1			12.1			10.9			9.7					45
50	11.2	10.1			13.1			12.1			10.9			9.7			8.5		50
55	10.7	9.8			13.1			12.1			10.9			9.7			8.5		55
60	10.2	9.3			13			12.1			10.9			9.7			8.5		60
65	9.7	8.8			12.9			12.1			10.9			9.7			8.5		65
70	9.2	8.4			12.7	10.2		12			10.9			9.7			8.5		70
75	8.8	8	7.1	12.4	10			11.8			10.9			9.7			8.5		75
80	8.4	7.7	6.8	12	9.7			11.6	9.4		10.8	9		9.7			8.5		80
85	8	7.3	6.5	11.6	9.4			11.4	9.3		10.7	8.9		9.6	8.3		8.5		85
90	7.7	7	6.2	11.3	9.2			11.1	9		10.4	8.6		9.5	8.1		8.5	7.3	90
95	7.4	6.8	6	11	8.9			10.8	8.8		10.2	8.4		9.3	7.9		8.5	7.3	95
100	7.2	6.5	5.8	10.7	8.7	6.8		10.5	8.5	6.8	9.9	8.2		9.1	7.8		8.5	7.3	100
105	6.9	6.3	5.7	10.4	8.4	6.8	10.2	8.3	6.8	9.7	8.1	6.6	8.9	7.6			8.3	7.3	105
110	6.7	6.1	5.6	10.1	8.2	6.6	9.9	8.1	6.7	9.5	7.9	6.5	8.7	7.5	6.3	8.2	7.1	6.1	110
115	6.4	5.9	5.6	9.8	8	6.5	9.7	7.9	6.5	9.3	7.7	6.4	8.6	7.3	6.3	8.1	7	6.1	115
120	6.2	5.8	5.6	9.5	7.8	6.4	9.4	7.7	6.4	9.1	7.5	6.3	8.4	7.2	6.2	8	6.9	6	120
125				9.2	7.6	6.2	9.2	7.6	6.3	8.9	7.4	6.2	8.2	7	6.1	7.8	6.8	6	125
130				9	7.5	6.1	9	7.4	6.1	8.6	7.2	6.1	8.1	6.9	6	7.7	6.6	5.9	130
135				8.7	7.3	6	8.7	7.2	6.1	8.4	7.1	6.1	7.9	6.8	6	7.6	6.5	5.9	135
140				8.5	7.1	5.9	8.5	7.1	6	8.2	6.9	6	7.8	6.7	5.9	7.4	6.4	5.8	140
145				8.2	7	5.9	8.3	6.9	5.9	8.1	6.8	5.9	7.6	6.6	5.8	7.3	6.3	5.8	145
150				8	6.8	5.8	8.1	6.8	5.8	7.9	6.7	5.9	7.5	6.5	5.8	7.2	6.3	5.7	150
155				7.8	6.7	5.7	7.9	6.7	5.8	7.7	6.6	5.8	7.4	6.4	5.8	7.1	6.2	5.7	155
160				7.7	6.6	5.7	7.8	6.6	5.7	7.6	6.5	5.8	7.3	6.3	5.7	7	6.1	5.7	160
165				7.5	6.4	5.6	7.6	6.5	5.6	7.4	6.4	5.7	7.2	6.3	5.6	6.9	6.1	5.6	165
170				7.3	6.3	5.6	7.5	6.5	5.6	7.3	6.4	5.6	7.1	6.2	5.6	6.8	6	5.6	170
175				7.2	6.1	5.6	7.3	6.3	5.5	7.2	6.3	5.6	6.9	6.1	5.6	6.7	5.9	5.6	175
180				7.1	6.1	5.6	7.1	6.2	5.5	7.1	6.2	5.6	6.9	6.1	5.5	6.6	5.9	5.5	180
185				6.9	6	5.6	7	6.1	5.5	7	6.1	5.5	6.8	6	5.5	6.5	5.9	5.5	185
190				6.8	5.9	5.6	6.9	6	5.5	6.8	6	5.5	6.7	6	5.5	6.3	5.8	5.5	190
195				6.6	5.8	5.6	6.8	5.9	5.5	6.8	6	5.5	6.6	5.9	5.4	6.1	5.8	5.4	195
200				6.5	5.8	5.6	6.7	5.9	5.5	6.7	5.9	5.5	6.5	5.9	5.4	5.8	5.8	5.4	200
205				6.3	5.7	5.6	6.6	5.8	5.5	6.5	5.8	5.5	6.4	5.9	5.4	5.5	5.8	5.4	205
210				6.2	5.7		6.5	5.8	5.5	6.5	5.8	5.5	6.2	5.8	5.4	5.3	5.8	5.4	210
215				6.1	5.7		6.3	5.7	5.5	6	5.7	5.5	5.9	5.8	5.4	5	5.6	5.4	215
220				5.9	5.5		6.1	5.7	5.5	5.7	5.7	5.5	5.6	5.7	5.4	4.8	5.4	5.4	220
225							6	5.7		5.5	5.6	5.5	5.3	5.7	5.4	4.5	5.1	5.3	225
230							5.8			5.3	5.5	5.5	4.9	5.6	5.4	4.3	4.9	5.2	230
235							5.6			5.1	5.3	5.4	4.5	5.2	5.4	4	4.6	4.9	235
240										4.9	5.1		4.2	4.8	5.1	3.8	4.3	4.6	240
245										4.8			3.9	4.4	4.6	3.5	4.1	4.2	245
250													3.5	4		3.2	3.8	3.9	250
255													3.2	3.6		2.9	3.4	3.6	255
260													3	3.3		2.6	3.1		260
265																	2.7		265
I	0				46/ 0			92/46/ 0			92/46			92			100		I
II	0				92/46			92/92/92			92/92			92			100		II
III	0				92/92			92/92/92			92/92			92			100		III
IV	0				46/92			46/92/92			92/92			92			100		IV
V	0				46/92			46/46/92			46/92			92			100		V

\* three-parted folding jib / fléchette pliante à 3 éléments

TAB 133021 / 133022 / 133023





# Lifting heights. Hauteurs de levage.

LTM 1200/1

Folding jib.  
Fléchette pliante.

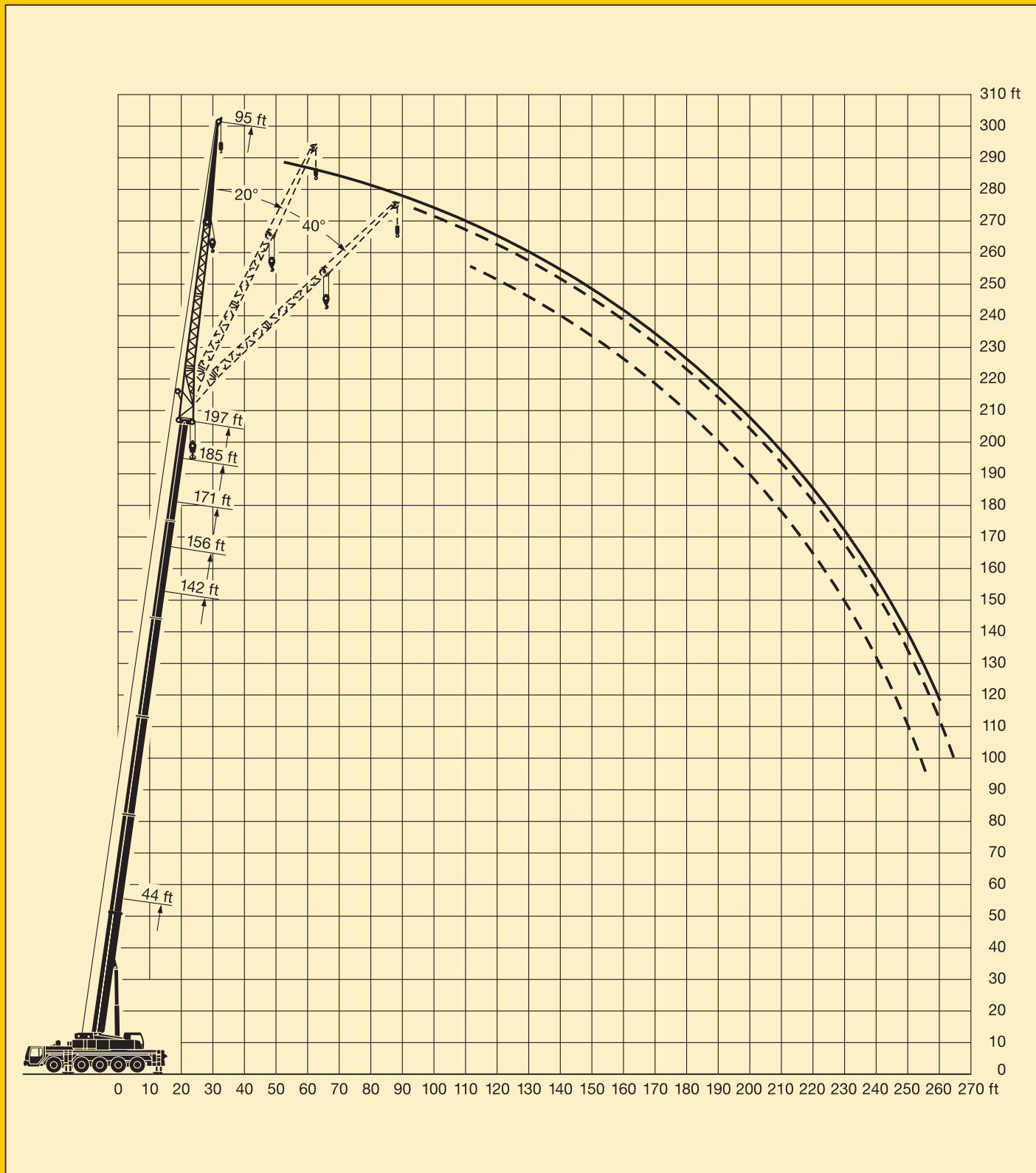



# Lifting capacities on the folding jib. Forces de levage à la fléchette pliante.

LTM 1200/1



44 ft – 197 ft

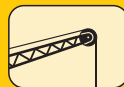

118 ft\*



360°



152100 lbs

85%

ft	44 ft			142 ft			156 ft			171 ft			185 ft			197 ft		ft	
	118 ft			118 ft			118 ft			118 ft			118 ft			118 ft			
	0°	20°	40°	0°	20°	40°	0°	20°	40°	0°	20°	40°	0°	20°	40°	0°	20°		
20	9.8																	20	
22	9.7																	22	
24	9.6																	24	
26	9.5																	26	
28	9.4																	28	
30	9.4																	30	
32	9.3																	32	
34	9.2																	34	
36	9																	36	
38	8.9			9														38	
40	8.8			9														40	
45	8.5			9			8.3											45	
50	8.2			9			8.3			7.5			6.6					50	
55	7.8			9			8.3			7.5			6.6					55	
60	7.4	6.7		9			8.3			7.5			6.6			5.6		60	
65	7	6.4		9			8.3			7.5			6.6			5.6		65	
70	6.6	6			8.8		8.3			7.5			6.6			5.6		70	
75	6.3	5.8			8.6		8.2			7.5			6.6			5.6		75	
80	6	5.5			8.4		8			7.5			6.6			5.6		80	
85	5.7	5.2			8.2	6.3	7.9			7.3			6.6			5.6		85	
90	5.5	5	4.5		7.9	6.2	7.7	5.8		7.2	5.6		6.4			5.6		90	
95	5.3	4.8	4.4		7.7	6.1	7.5	5.8		7	5.6		6.3			5.6		95	
100	5.1	4.6	4.2		7.4	5.9	7.2	5.8		6.8	5.5		6.2	5.1		5.6		100	
105	4.9	4.5	4.1		7.2	5.7	7	5.6		6.6	5.4		6.1	5.1		5.6	4.9	105	
110	4.7	4.3	3.9		6.9	5.5	6.8	5.5		6.5	5.3		5.9	5		5.6	4.8	110	
115	4.5	4.2	3.8		6.7	5.4	6.6	5.3	4.1	6.3	5.2		5.8	4.9		5.5	4.7	115	
120	4.4	4.1	3.7		6.5	5.2	6.4	5.2	4.1	6.1	5		5.7	4.8		5.4	4.6	120	
125	4.3	3.9	3.6		6.3	5.1	6.2	5.1	4.1	6	4.9	3.9	5.6	4.7		5.3	4.5	125	
130	4.1	3.8	3.5		6.1	5	6	5	4.1	5.8	4.8	3.9	5.4	4.6	3.6	5.1	4.4	130	
135	4	3.7	3.5		5.9	4.9	5.9	4.8	4.1	5.7	4.7	3.9	5.3	4.5	3.6	5.1	4.3	135	
140	3.9	3.6	3.4		5.8	4.8	4	5.7	4.7	4	5.5	4.6	3.9	5.2	4.4	3.6	5	4.3	140
145	3.7	3.5			5.6	4.7	3.9	5.6	4.6	3.9	5.4	4.5	3.9	5.1	4.3	3.6	4.9	4.2	145
150	3.6	3.5			5.5	4.6	3.9	5.5	4.5	3.9	5.3	4.5	3.8	5	4.2	3.6	4.8	4.1	150
155					5.3	4.5	3.8	5.3	4.4	3.8	5.2	4.4	3.7	4.9	4.2	3.6	4.7	4.1	155
160					5.2	4.4	3.7	5.2	4.3	3.8	5.1	4.3	3.7	4.8	4.1	3.6	4.6	4	160
165					5.1	4.3	3.7	5.1	4.3	3.7	5	4.2	3.7	4.8	4	3.6	4.5	3.9	165
170					4.9	4.2	3.6	5	4.2	3.6	4.9	4.2	3.6	4.7	4	3.6	4.4	3.9	170
175					4.8	4.1	3.6	4.9	4.1	3.6	4.8	4.1	3.6	4.6	3.9	3.5	4.4	3.8	175
180					4.7	4.1	3.5	4.8	4.1	3.6	4.7	4	3.6	4.5	3.9	3.5	4.3	3.8	180
185					4.6	4	3.5	4.7	4	3.5	4.6	3.9	3.5	4.4	3.9	3.5	4.3	3.7	185
190					4.6	3.9	3.4	4.6	4	3.5	4.5	3.9	3.5	4.4	3.8	3.5	4.2	3.7	190
195					4.5	3.9	3.4	4.5	3.9	3.4	4.4	3.9	3.4	4.3	3.8	3.4	4.2	3.7	195
200					4.4	3.8	3.4	4.4	3.9	3.4	4.4	3.8	3.4	4.2	3.7	3.4	4.1	3.7	200
205					4.3	3.8	3.4	4.3	3.8	3.4	4.3	3.8	3.4	4.2	3.7	3.4	4.1	3.6	205
210					4.2	3.7	3.4	4.3	3.8	3.4	4.3	3.8	3.3	4.1	3.7	3.3	4	3.6	210
215					4.1	3.6	3.4	4.2	3.7	3.4	4.2	3.7	3.3	4.1	3.7	3.3	4	3.6	215
220					4	3.5	3.4	4.1	3.7	3.4	4.2	3.7	3.3	4	3.6	3.3	3.9	3.6	220
225					3.9	3.5	3.4	4.1	3.6	3.4	4.1	3.7	3.3	4	3.6	3.3	3.9	3.5	225
230					3.9	3.4		4	3.6	3.4	4.1	3.6	3.3	3.9	3.6	3.3	3.8	3.5	230
235					3.8	3.4		3.9	3.5	3.4	4	3.6	3.3	3.9	3.6	3.3	3.5	3.5	235
240					3.7	3.4		3.9	3.4	3.4	3.9	3.6	3.3	3.9	3.6	3.3	3.3	3.5	240
245								3.8	3.4		3.8	3.5	3.3	3.7	3.5	3.3	3	3.5	245
250								3.7	3.4		3.8	3.5	3.3	3.4	3.5	3.3	2.8	3.4	250
255								3.6	3.4		3.7	3.4	3.3	3.1	3.5	3.3	2.5	3.3	255
260											3.6	3.4		2.8	3.4	3.3		3.1	260
265											3.4	3.4			3.2	3.2		2.7	265
270															2.8				270
275															2.5				275
I	0				46/ 0			92/46/ 0			92/46			92			100		I
II	0				92/46			92/92/92			92/92			92			100		II
III	0				92/92			92/92/92			92/92			92			100		III
IV	0				46/92			46/92/92			92/92			92			100		IV
V	0				46/92			46/46/92			46/92			92			100		V

\* four-parted folding jib / fléchette pliante à 4 éléments

TAB 133021 / 133022 / 133023



# Lifting heights. Hauteurs de levage.

LTM 1200/1

Folding jib.  
Fléchette pliante.

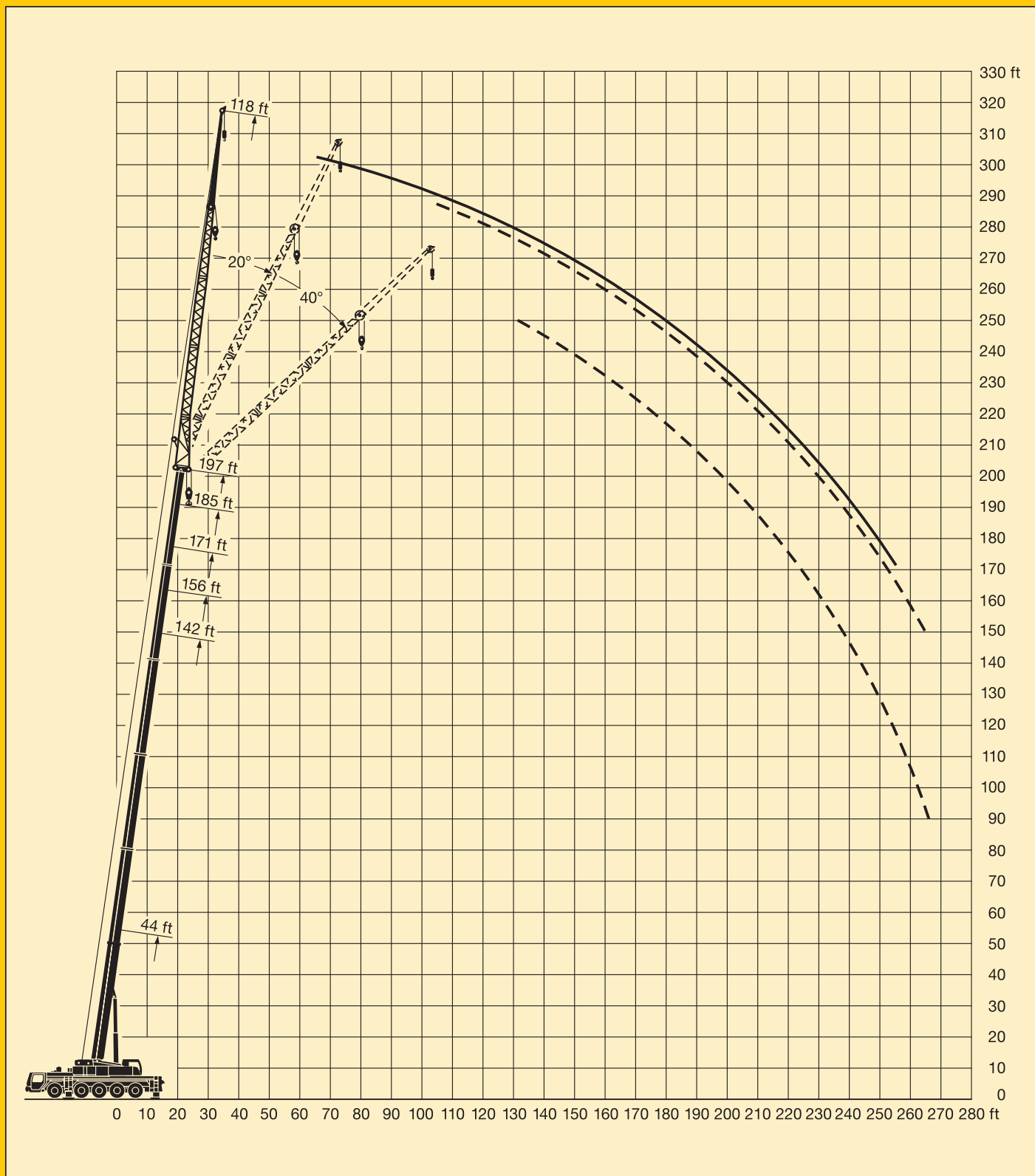



# Lifting capacities on the folding jib with boom extension.

LTM 1200/1

## Forces de levage à la fléchette pliante avec télescope rallongé.



44 ft – 197 ft

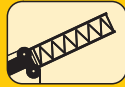

23 ft

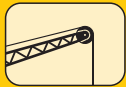

40 ft\*



360°

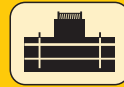

152100 lbs

85%

ft	44 ft + 23 ft			156 ft + 23 ft			171 ft + 23 ft			185 ft + 23 ft			197 ft + 23 ft			ft
	40 ft			40 ft			40 ft			40 ft			40 ft			
	0°	20°	40°	0°	20°	40°	0°	20°	40°	0°	20°	40°	0°	20°	40°	
11	21.8															11
12	21.8															12
13	21.8															13
14	21.8															14
15	21.8															15
16	21.8															16
17	21.8															17
18	21.7															18
20	21.6															20
22	21.4	21.8														22
24	21.2	21.7														24
26	21	21.5														26
28	20.6	21.1														28
30	20.2	20.6														30
32	19.7	20	20.1													32
34	19.1	19.5	19.8													34
36	18.5	18.9	19.3	21.8												36
38	18	18.4	18.7	21.8			20.2									38
40	17.5	17.8	18.2	21.8			20.2									40
45	16.3	16.4	16.8	21.7			20.2			18.2			15.8			45
50	15.1	15.2	15.5	21.5	21.1		20.1			18.2			15.8			50
55	13.9	14.2	14.4	21.2	20.8		20			18.2			15.7			55
60	12.7	13.3	13.4	21	20.2		19.8	19.6		18.2	18.2		15.6			60
65	11.6	12.4	12.5	20.8	19.5	18.4	19.6	19	18	18	17.8		15.5	15.3		65
70	10.6	11.5	11.8	20.2	18.9	17.8	19.2	18.4	17.5	17.8	17.4	16.8	15.3	15.2		70
75	9.6	10.6	11.1	19.4	18.2	17.2	18.7	17.9	17	17.5	17	16.5	15.1	15		75
80	8.7	9.6	10.2	18.8	17.5	16.6	18.1	17.4	16.4	17.2	16.7	16	14.7	14.8	14.4	80
85	7.9	8.6	9	18.1	16.9	16	17.6	16.8	15.9	16.8	16.3	15.6	14.3	14.5	14	85
90	7.1	7.6	8.3	17.5	16.3	15.5	17.2	16.2	15.4	16.5	15.9	15.1	14	14.1	13.7	90
95	6.3	7		16.9	15.7	15	16.7	15.7	14.9	16.1	15.4	14.7	13.6	13.7	13.3	95
100				16.4	15.2	14.5	16.3	15.2	14.5	15.7	14.9	14.3	13.3	13.4	13	100
105				15.8	14.6	14	15.8	14.7	14.1	15.4	14.5	13.9	13	13	12.7	105
110				15.2	14.2	13.6	15.3	14.2	13.7	14.9	14.1	13.5	12.7	12.7	12.4	110
115				14.6	13.8	13.2	14.7	13.8	13.3	14.4	13.7	13.2	12.4	12.4	12.1	115
120				14	13.3	12.9	14.1	13.4	12.9	13.9	13.3	12.9	12.1	12.1	11.8	120
125				13.4	12.9	12.5	13.6	13	12.6	13.5	13	12.6	11.8	11.8	11.5	125
130				12.8	12.5	12.2	13.1	12.7	12.3	13	12.7	12.2	11.4	11.5	11.3	130
135				12.3	12.2	11.9	12.6	12.3	12	12.6	12.3	12	11.1	11.2	11	135
140				11.8	11.8	11.6	12.1	12	11.7	12.1	12	11.7	10.8	10.9	10.8	140
145				11.3	11.4	11.3	11.6	11.6	11.4	11.7	11.7	11.4	10.4	10.6	10.6	145
150				10.8	10.9	11	11.2	11.2	11.2	11.3	11.3	11.2	10	10.2	10.3	150
155				10.3	10.5	10.6	10.8	10.8	10.9	10.9	10.9	11	9.6	9.9	10	155
160				9.9	10	10.2	10.4	10.4	10.5	10.5	10.6	10.7	9.3	9.5	9.7	160
165				9.4	9.6	9.8	10	10.1	10.2	10.1	10.2	10.3	8.9	9.2	9.4	165
170				9	9.1	9.3	9.6	9.7	9.9	9.6	9.8	10	8.5	8.8	9.1	170
175				8.6	8.7	8.8	9.2	9.3	9.5	9.2	9.5	9.7	8	8.4	8.7	175
180				8.1	8.3	8.4	8.8	9	9.1	8.8	9.1	9.3	7.6	8	8.2	180
185				7.7	7.9		8.4	8.6	8.7	8.4	8.7	8.9	7.2	7.6	7.8	185
190				7.3	7.5		8.1	8.2	8.3	8.1	8.3	8.4	6.8	7.3	7.4	190
195				7	7.1		7.7	7.9	7.9	7.7	7.9	8	6.4	6.9	7	195
200				6.6	6.7		7.4	7.5		7.4	7.5	7.6	6	6.6	6.7	200
205							7.1	7.2		6.8	7	7.2	5.7	6.2	6.3	205
210							6.8	6.8		5.9	6.2		5.4	5.8	5.9	210
215							6.4	6.5		5.5	5.8		5.1	5.5	5.5	215
220										5	5.3		4.7	5	5.1	220
225										4.6	4.9		4.3	4.6		225
230													3.9	4.2		230
235													3.6	3.8		235
240													3.2	3.4		240
I		0			0			46			92			100		I
II		0			92			92			92			100		II
III		0			92			92			92			100		III
IV		0			92			92			92			100		IV
V		0			92			92			92			100		V

\* one-parted folding jib / fléchette pliante à 1 élément

TAB 133024 / 133025 / 133026

# The LTM 1200/1 can be equipped to tackle any job.



# Lifting heights. Hauteurs de levage.

LTM 1200/1

Folding jib.  
Fléchette pliante.

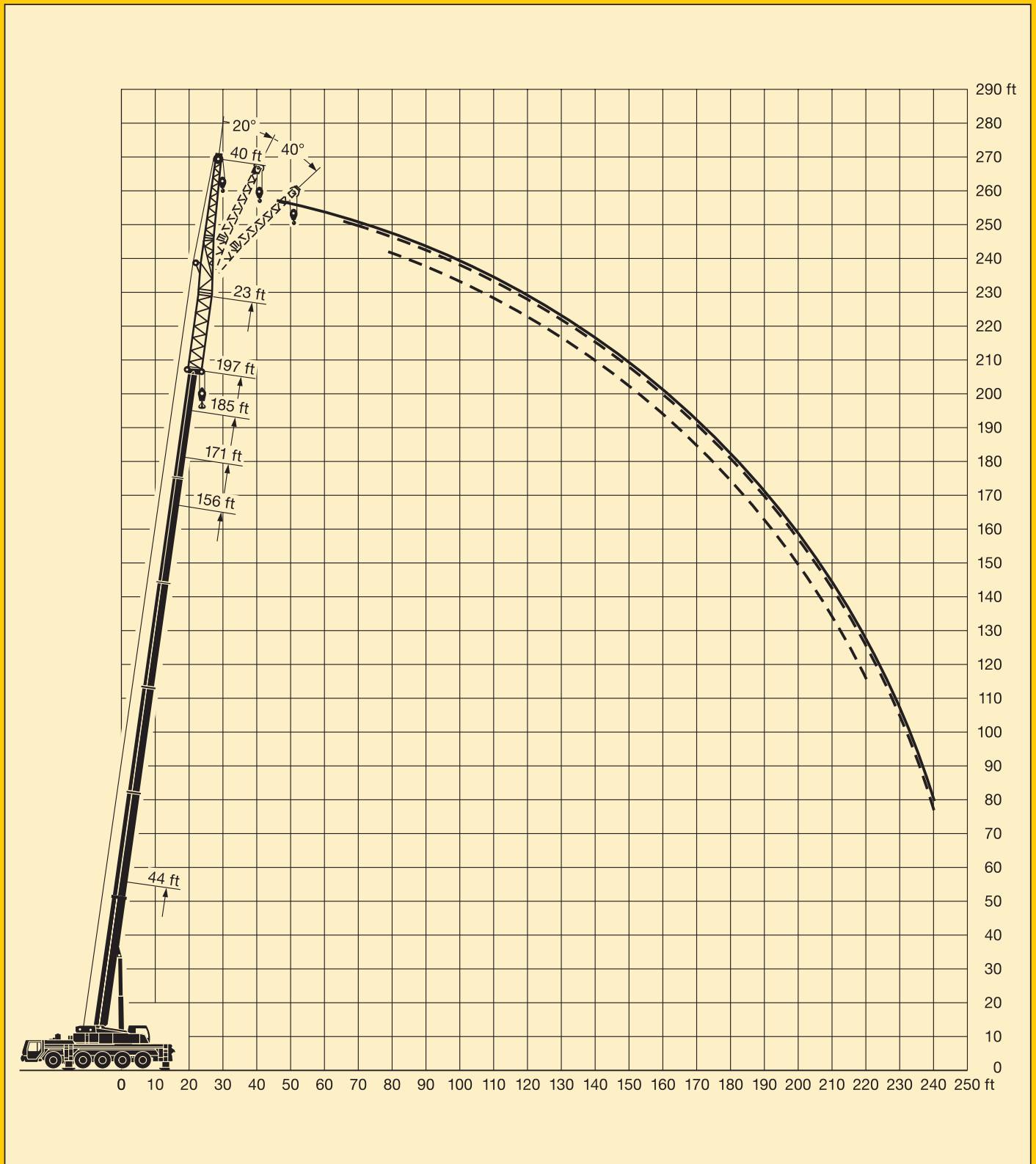



# Lifting capacities on the folding jib with boom extension.

LTM 1200/1

## Forces de levage à la fléchette pliante avec télescope rallongé.



44 ft - 197 ft

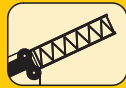

23 ft

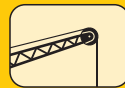

63 ft\*



360°

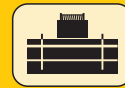

152100 lbs

85%

ft	44 ft + 23 ft			156 ft + 23 ft			171 ft + 23 ft			185 ft + 23 ft			197 ft + 23 ft			ft
	63 ft			63 ft			63 ft			63 ft			63 ft			
	0°	20°	40°	0°	20°	40°	0°	20°	40°	0°	20°	40°	0°	20°	40°	
13	15.8															13
14	15.8															14
16	15.8															16
18	15.8															18
20	15.8															20
22	15.7															22
24	15.7															24
26	15.6															26
28	15.6															28
30	15.5															30
32	15.4															32
34	15.3															34
36	15.1	15.5														36
38	14.7	15.2														38
40	14.4	15														40
45	13.4	14		15.8			14.6									45
50	12.6	13.1	12.1	15.7			14.6			13.1			11.6			50
55	11.8	12.2	12	15.6			14.5			13.1			11.6			55
60	11.1	11.3	11.7	15.6			14.5			13.1			11.6			60
65	10.4	10.5	10.9	15.5	14.8		14.5			13.1			11.5			65
70	9.7	9.9	10.2	15.3	14.4		14.4	13.9		13.1			11.4			70
75	9.1	9.3	9.5	15	13.9		14.2	13.6		13.1			11.3			75
80	8.6	8.7	8.9	14.4	13.4		13.9	13.2		13	12.6		11.2	10.9		80
85	8	8.1	8.4	13.9	13	11.9	13.4	12.7	11.6	12.8	12.3		11.1	10.7		85
90	7.5	7.7	7.9	13.5	12.5	11.6	13	12.3	11.4	12.5	11.9	10.9	10.9	10.5		90
95	7	7.3	7.5	13	12	11.2	12.7	11.9	11.1	12.2	11.6	10.8	10.6	10.3		95
100	6.4	6.9	7.1	12.6	11.6	10.9	12.3	11.5	10.8	12	11.3	10.6	10.4	10.1	9.6	100
105	5.9	6.5	6.8	12.2	11.2	10.5	12	11.1	10.5	11.7	10.9	10.3	10.2	9.8	9.4	105
110	5.4	5.9	6.7	11.8	10.8	10.2	11.7	10.8	10.2	11.5	10.6	10	10	9.6	9.1	110
115	4.9	5.3		11.4	10.4	9.9	11.4	10.4	9.9	11.2	10.3	9.8	9.8	9.3	8.9	115
120				11	10	9.5	11.1	10.1	9.6	11	10	9.5	9.6	9	8.7	120
125				10.6	9.7	9.2	10.7	9.8	9.3	10.6	9.7	9.2	9.4	8.8	8.4	125
130				10.3	9.4	9	10.3	9.5	9	10.3	9.4	9	9.2	8.5	8.2	130
135				9.9	9.1	8.7	10	9.2	8.8	10	9.2	8.8	8.9	8.3	8	135
140				9.6	8.8	8.5	9.7	8.9	8.6	9.7	8.9	8.6	8.7	8.1	7.9	140
145				9.2	8.5	8.3	9.4	8.7	8.4	9.4	8.7	8.4	8.4	7.9	7.7	145
150				8.9	8.3	8	9.1	8.4	8.1	9.1	8.4	8.2	8.2	7.7	7.5	150
155				8.6	8	7.8	8.8	8.2	7.9	8.8	8.2	8	8	7.5	7.3	155
160				8.3	7.8	7.6	8.5	7.9	7.7	8.6	8	7.8	7.8	7.3	7.2	160
165				8	7.6	7.5	8.3	7.7	7.6	8.4	7.8	7.6	7.5	7.2	7	165
170				7.8	7.4	7.3	8	7.5	7.4	8.1	7.6	7.5	7.3	7	6.9	170
175				7.6	7.2	7.2	7.8	7.4	7.3	7.9	7.4	7.3	7	6.9	6.8	175
180				7.3	7	7	7.5	7.2	7.2	7.7	7.2	7.1	6.7	6.7	6.7	180
185				7	6.8	6.9	7.2	7	7	7.4	7.1	7	6.5	6.6	6.5	185
190				6.7	6.7	6.7	6.9	6.8	6.9	7.1	7	6.9	6.2	6.4	6.4	190
195				6.4	6.4	6.6	6.6	6.7	6.8	6.8	6.8	6.8	5.9	6.2	6.3	195
200				6.1	6.2	6.3	6.3	6.5	6.7	6.4	6.7	6.7	5.6	6	6.2	200
205				5.8	5.9	6	6.1	6.3	6.5	6.1	6.5	6.6	5.3	5.7	6	205
210				5.5	5.6		5.9	6.1	6.3	5.9	6.2	6.5	5	5.4	5.6	210
215				5.3	5.3		5.7	5.8	6	5.5	5.9	6.1	4.7	5.1	5.4	215
220				5	5.1		5.5	5.6	5.7	5.1	5.6	5.8	4.4	4.8	5.1	220
225							5.2	5.4		4.7	5.2	5.4	4.2	4.5	4.7	225
230							5	5.1		4.3	4.8		3.9	4.3	4.4	230
235							4.9	4.9		3.9	4.4		3.6	4	4.1	235
240										3.6	3.9		3.2	3.7	3.8	240
245										3.3	3.5		2.9	3.3		245
250														2.9		250
255														2.6		255
I		0			0			46			92			100		I
II		0			92			92			92			100		II
III		0			92			92			92			100		III
IV		0			92			92			92			100		IV
V		0			92			92			92			100		V

\* bi-parted folding jib / fléchette pliante à 2 éléments

TAB 133024 / 133025 / 133026



# Lifting heights. Hauteurs de levage.

LTM 1200/1

Folding jib.  
Fléchette pliante.

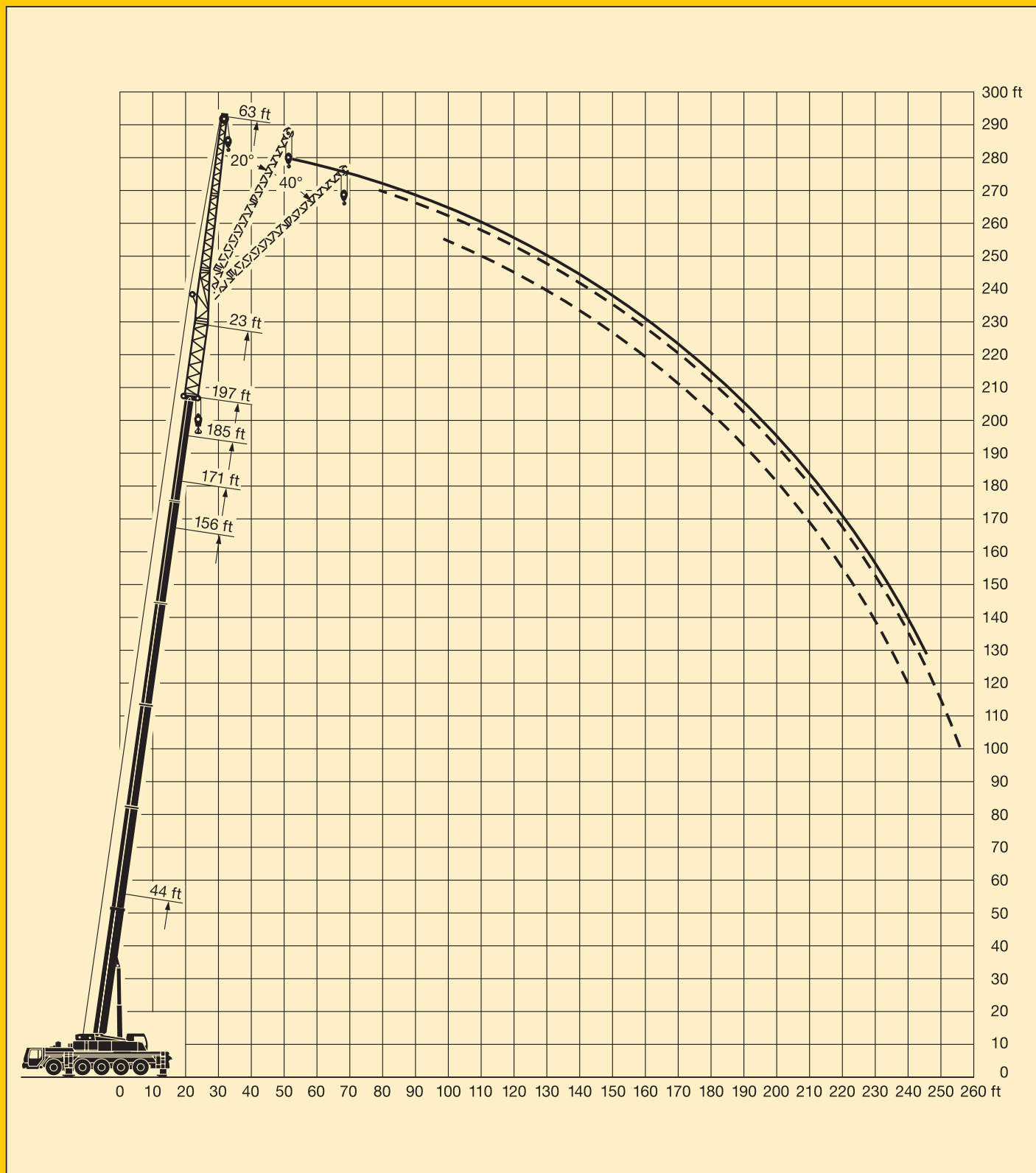



# Lifting capacities on the folding jib with boom extension.

LTM 1200/1

## Forces de levage à la fléchette pliante avec télescope rallongé.



44 ft - 197 ft



23 ft

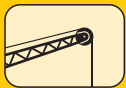

72 ft\*



360°

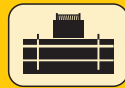

152100 lbs

85%

ft	44 ft + 23 ft			156 ft + 23 ft			171 ft + 23 ft			185 ft + 23 ft			197 ft + 23 ft			ft
	72 ft			72 ft			72 ft			72 ft			72 ft			
	0°	20°	40°	0°	20°	40°	0°	20°	40°	0°	20°	40°	0°	20°	40°	
14	12.7															14
15	12.7															15
16	12.7															16
17	12.7															17
18	12.6															18
20	12.6															20
22	12.6															22
24	12.6															24
26	12.6															26
28	12.6															28
30	12.6															30
32	12.5															32
34	12.5															34
36	12.4															36
38	12.4	12.1														38
40	12.3	12.1														40
45	12.2	12.1		12.6			12									45
50	11.7	11.9		12.6			11.9			11			9.8			50
55	11	11.4		12.6			11.9			11			9.8			55
60	10.4	10.8	10.4	12.6			11.9			11			9.8			60
65	9.8	10.1	10.3	12.5			11.9			10.9			9.8			65
70	9.2	9.4	9.8	12.4	11.9		11.8			10.9			9.8			70
75	8.7	8.9	9.3	12.4	11.9		11.8			10.9			9.8			75
80	8.2	8.4	8.7	12.3	11.9		11.7	11.4		10.9	10.9		9.7			80
85	7.7	7.9	8.2	12.2	11.7		11.6	11.4		10.8	10.9		9.7	9.7		85
90	7.3	7.4	7.7	12.1	11.4	10.2	11.4	11.1		10.8	10.7		9.6	9.5		90
95	6.9	7	7.3	11.9	11	10.1	11.2	10.8		10.7	10.5		9.5	9.3		95
100	6.5	6.7	6.9	11.5	10.6	10	10.9	10.5	9.9	10.6	10.3	9.7	9.4	9.1		100
105	6.1	6.4	6.6	11.1	10.3	9.7	10.8	10.2	9.6	10.4	10	9.5	9.2	9	8.6	105
110	5.6	6.1	6.3	10.7	9.9	9.4	10.6	9.9	9.3	10.3	9.7	9.2	9	8.7	8.3	110
115	5.2	5.7	6	10.4	9.6	9.1	10.4	9.6	9.1	10.1	9.4	9	8.8	8.5	8.1	115
120	4.8	5.3		10	9.3	8.8	10.2	9.3	8.8	9.9	9.1	8.7	8.6	8.2	7.9	120
125				9.7	9	8.6	9.8	9	8.6	9.6	8.9	8.5	8.4	8	7.7	125
130				9.4	8.7	8.3	9.5	8.7	8.3	9.4	8.6	8.3	8.2	7.8	7.5	130
135				9.1	8.4	8.1	9.2	8.5	8.1	9.1	8.4	8.1	8	7.6	7.4	135
140				8.8	8.2	7.9	8.9	8.2	7.9	8.8	8.2	7.9	7.9	7.4	7.2	140
145				8.5	7.9	7.7	8.6	8	7.7	8.6	8	7.7	7.7	7.2	7	145
150				8.3	7.7	7.4	8.3	7.8	7.5	8.4	7.8	7.5	7.5	7.1	6.9	150
155				8	7.4	7.3	8.1	7.6	7.3	8.1	7.6	7.3	7.3	6.9	6.7	155
160				7.8	7.2	7.1	7.9	7.4	7.2	7.9	7.4	7.2	7.2	6.7	6.6	160
165				7.5	7	6.9	7.6	7.2	7	7.7	7.2	7	7	6.6	6.5	165
170				7.3	6.8	6.7	7.4	7	6.8	7.5	7	6.9	6.8	6.4	6.3	170
175				7.1	6.7	6.6	7.2	6.8	6.7	7.3	6.8	6.7	6.6	6.3	6.2	175
180				6.8	6.5	6.5	7	6.6	6.5	7.1	6.7	6.6	6.5	6.2	6.1	180
185				6.6	6.4	6.4	6.8	6.5	6.4	6.9	6.5	6.5	6.3	6.1	6	185
190				6.5	6.2	6.3	6.6	6.3	6.3	6.8	6.4	6.3	6.1	6	5.9	190
195				6.2	6.1	6.2	6.4	6.2	6.2	6.6	6.3	6.3	5.8	5.9	5.9	195
200				5.9	5.9	6.1	6.2	6.1	6.1	6.4	6.2	6.2	5.6	5.8	5.8	200
205				5.7	5.8	6	6	6	6.1	6.1	6	6.1	5.3	5.6	5.7	205
210				5.4	5.6	5.8	5.8	5.8	6	5.9	5.9	6	5.1	5.4	5.6	210
215				5.2	5.4	5.5	5.6	5.7	5.9	5.6	5.8	5.9	4.8	5.2	5.5	215
220				5	5.2		5.4	5.6	5.7	5.3	5.7	5.9	4.5	5	5.3	220
225				4.8	4.9		5.2	5.4	5.5	5	5.5	5.7	4.3	4.7	5	225
230				4.6			5	5.2		4.6	5.2	5.4	4	4.4	4.7	230
235				4.3			4.8	5		4.2	4.8	5	3.8	4.2	4.4	235
240							4.6	4.8		3.9	4.4	4.5	3.5	3.9	4.1	240
245							4.5	4.6		3.5	4		3.2	3.7	3.8	245
250										3.2	3.6		2.9	3.3		250
255										2.9	3.2		2.6	3		255
260										2.6	2.9			2.6		260
I		0			0			46			92			100		I
II		0			92			92			92			100		II
III		0			92			92			92			100		III
IV		0			92			92			92			100		IV
V		0			92			92			92			100		V

\* bi-parted folding jib / fléchette pliante à 2 éléments

TAB 133024 / 133025 / 133026

# La LTM 1200/1 possède l'équipement qui convient à chaque problème.





# Lifting heights. Hauteurs de levage.

LTM 1200/1

Folding jib.  
Fléchette pliante.

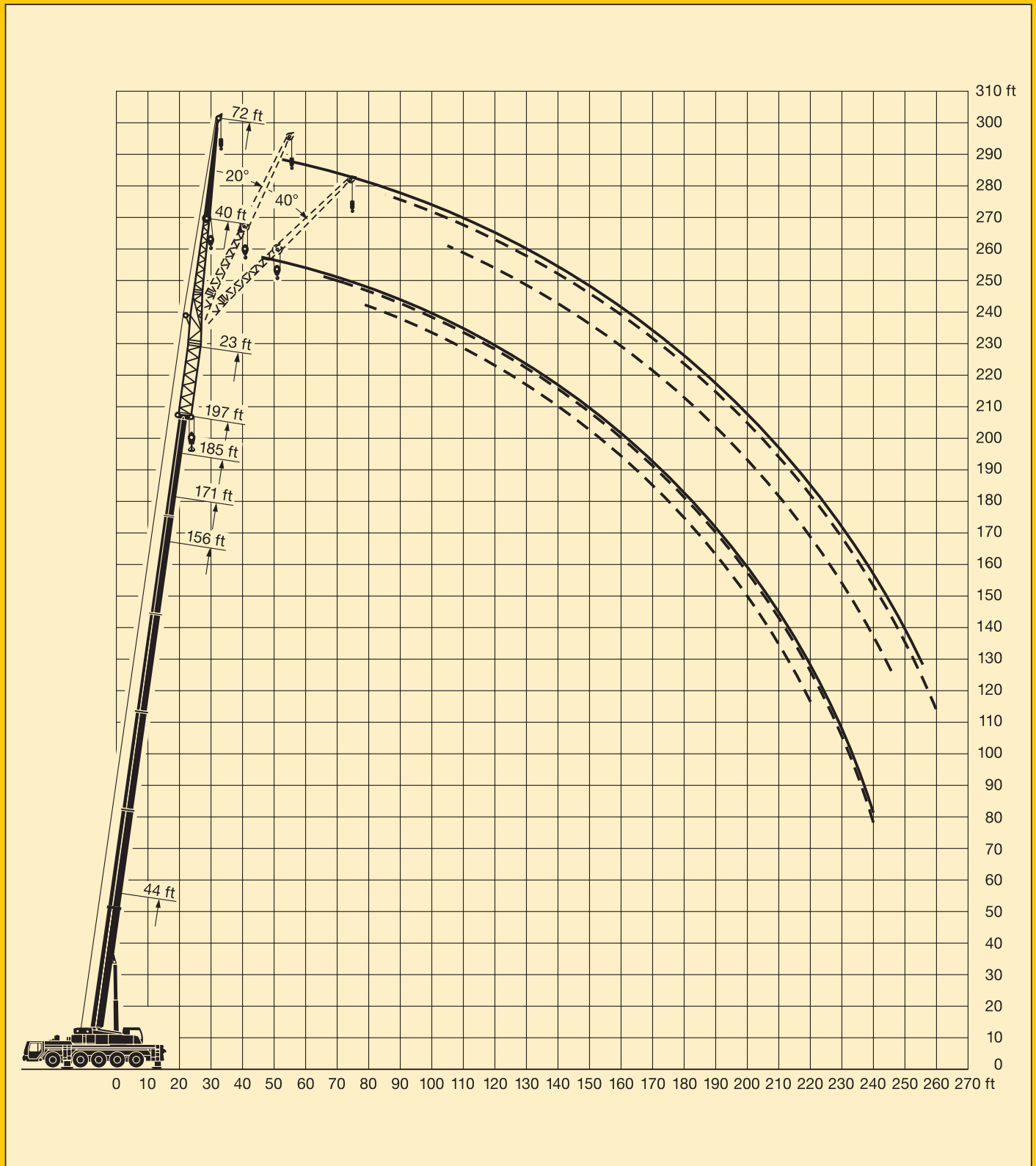



# Lifting capacities on the folding jib with boom extension.

LTM 1200/1

## Forces de levage à la fléchette pliante avec télescope rallongé.



44 ft – 197 ft



23 ft

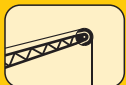

86 ft\*



360°



152100 lbs

85%

ft	44 ft + 23 ft			156 ft + 23 ft			171 ft + 23 ft			185 ft + 23 ft			197 ft + 23 ft		ft
	86 ft			86 ft			86 ft			86 ft			86 ft		
	0°	20°	40°	0°	20°	40°	0°	20°	40°	0°	20°	40°	0°	20°	
16	11.2														16
17	11.2														17
18	11.2														18
20	11.2														20
22	11.2														22
24	11.1														24
26	11.1														26
28	11.1														28
30	11.1														30
32	11.1														32
34	11														34
36	11														36
38	10.9														38
40	10.8														40
45	10.6	10.2		11.2						9.2					45
50	10.3	10		11.1			10.2			9.2					50
55	9.8	9.7		11.1			10.2			9.2					55
60	9.2	9.3		11.1			10.2			9.2			8		60
65	8.6	8.9		11			10.2			9.2			8		65
70	8	8.4	7.5	10.9			10.2			9.2			8		70
75	7.5	7.8	7.5	10.8			10.2			9.2			8		75
80	7.1	7.3	7.3	10.7	9.5		10.1			9.2			8		80
85	6.6	6.8	7.1	10.6	9.5		10	9		9.2			8		85
90	6.2	6.4	6.7	10.4	9.3		10	9		9.1	8.6		7.9	7.8	90
95	5.9	6.1	6.3	10.2	9.1		9.8	8.9		9	8.5		7.8	7.7	95
100	5.5	5.7	6	10	8.9		9.6	8.7		9	8.3		7.7	7.5	100
105	5.3	5.4	5.6	9.5	8.6	7.5	9.3	8.5	7.4	8.9	8.2		7.6	7.3	105
110	5.1	5.2	5.4	9.2	8.3	7.3	9	8.2	7.3	8.6	8	7	7.5	7.1	110
115	4.8	4.9	5.2	8.8	8	7.2	8.7	7.9	7.2	8.4	7.8	7	7.3	6.9	115
120	4.5	4.7	4.9	8.5	7.7	7.1	8.5	7.7	7.1	8.1	7.5	6.9	7.2	6.7	120
125	4.2	4.5	4.8	8.2	7.4	7	8.2	7.4	6.9	7.9	7.3	6.8	7	6.5	125
130	3.9	4.3	4.6	7.9	7.1	6.7	7.9	7.1	6.7	7.7	7.1	6.6	6.8	6.3	130
135	3.6	4	4.3	7.6	6.9	6.5	7.7	6.9	6.5	7.5	6.9	6.5	6.6	6.2	135
140	3.2			7.3	6.6	6.4	7.4	6.7	6.4	7.3	6.6	6.3	6.4	6	140
145				7	6.4	6.2	7.1	6.5	6.2	7.1	6.4	6.1	6.2	5.8	145
150				6.8	6.3	6	6.9	6.3	6	6.9	6.3	6	6.1	5.7	150
155				6.6	6.1	5.8	6.6	6.1	5.9	6.7	6.1	5.8	5.9	5.6	155
160				6.3	5.9	5.7	6.4	5.9	5.7	6.5	5.9	5.7	5.8	5.4	160
165				6.1	5.7	5.5	6.2	5.8	5.6	6.3	5.8	5.6	5.6	5.3	165
170				5.9	5.6	5.4	6	5.6	5.4	6.1	5.6	5.5	5.5	5.2	170
175				5.7	5.4	5.3	5.9	5.5	5.3	5.9	5.5	5.4	5.4	5.1	175
180				5.5	5.2	5.2	5.7	5.4	5.2	5.7	5.4	5.3	5.3	4.9	180
185				5.4	5.1	5.1	5.5	5.2	5.1	5.6	5.3	5.1	5.1	4.8	185
190				5.3	5	5	5.4	5.1	5	5.4	5.1	5.1	5	4.7	190
195				5.1	4.9	4.8	5.2	5	4.9	5.3	5	4.9	4.9	4.6	195
200				5	4.8	4.8	5.1	4.9	4.8	5.2	4.9	4.9	4.8	4.6	200
205				4.8	4.7	4.7	5	4.8	4.7	5.1	4.8	4.8	4.6	4.5	205
210				4.7	4.6	4.6	4.9	4.7	4.7	4.9	4.7	4.7	4.5	4.4	210
215				4.5	4.5	4.5	4.7	4.6	4.6	4.8	4.6	4.6	4.2	4.3	215
220				4.3	4.4	4.4	4.6	4.5	4.5	4.7	4.6	4.6	4	4.2	220
225				4.1	4.3	4.3	4.5	4.4	4.4	4.5	4.5	4.5	3.7	4.1	225
230				3.9	4.1		4.3	4.3	4.4	4.3	4.4	4.5	3.4	4.1	230
235				3.8	3.9		4.1	4.2	4.4	3.9	4.3	4.4	3.1	3.8	235
240				3.6	3.7		4	4.1	4.3	3.5	4.1	4.4	2.9	3.5	240
245				3.4			3.8	4		3.2	3.8	4.1	2.6	3.2	245
250							3.6	3.8		2.9	3.4	3.7		2.9	250
255							3.5	3.6		2.6	3.1	3.2		2.6	255
260							3.3	3.4			2.7				260
I	0			0			46			92			100	I	
II	0			92			92			92			100	II	
III	0			92			92			92			100	III	
IV	0			92			92			92			100	IV	
V	0			92			92			92			100	V	

\* three-parted folding jib / fléchette pliante à 3 éléments

TAB 133024 / 133025 / 133026



# Lifting heights. Hauteurs de levage.

LTM 1200/1

Folding jib.  
Fléchette pliante.

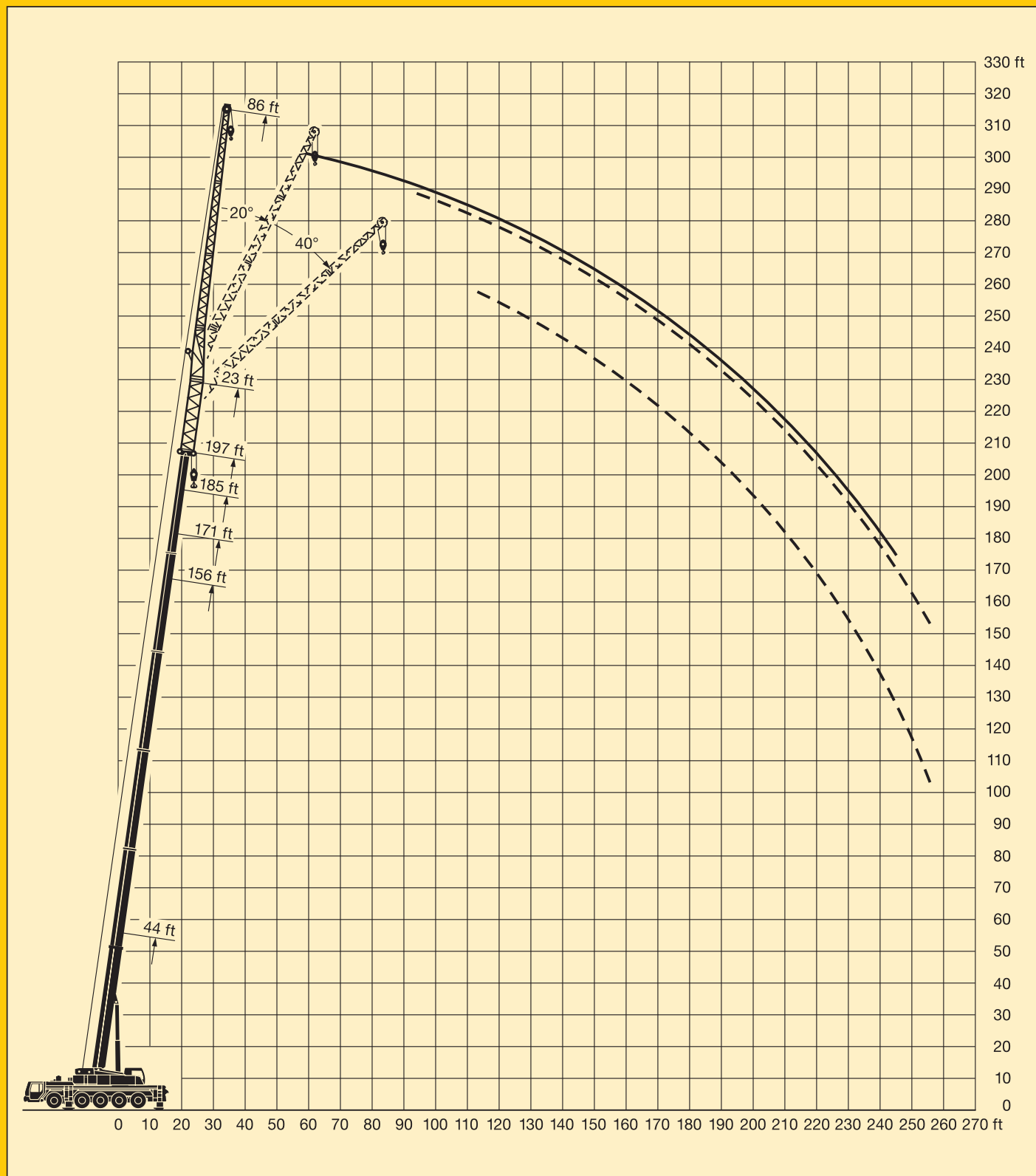



# Lifting capacities on the folding jib with boom extension.

LTM 1200/1

## Forces de levage à la fléchette pliante avec télescope rallongé.



44 ft - 197 ft

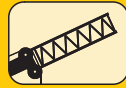

23 ft

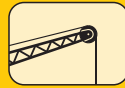

95 ft\*



360°

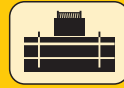

152100 lbs

85%

ft	44 ft + 23 ft			156 ft + 23 ft			171 ft + 23 ft			185 ft + 23 ft			197 ft + 23 ft		ft
	0°	20°	40°	0°	20°	40°	0°	20°	40°	0°	20°	40°	0°	20°	
20	9.2														20
22	9.2														22
24	9.2														24
26	9.2														26
28	9.2														28
30	9.2														30
32	9.1														32
34	9.1														34
36	9.1														36
38	9														38
40	9														40
45	8.9			9.2											45
50	8.8	8.3		9.2			8.5			7.8					50
55	8.6	8.2		9.2			8.5			7.8					55
60	8.3	8		9.1			8.5			7.8			6.8		60
65	8.1	7.7		9.1			8.5			7.8			6.8		65
70	7.7	7.4		9.1			8.5			7.8			6.8		70
75	7.2	7.2		9			8.5			7.8			6.8		75
80	6.8	6.9	6.4	8.9			8.5			7.8			6.8		80
85	6.4	6.6	6.2	8.9	8		8.4			7.8			6.8		85
90	6	6.2	6.1	8.8	7.9		8.3	7.6		7.7	7.3		6.8		90
95	5.7	5.9	6	8.7	7.7		8.2	7.5		7.7	7.2		6.8		95
100	5.4	5.6	5.8	8.5	7.6		8.2	7.4		7.6	7		6.8	6.6	100
105	5.1	5.3	5.6	8.4	7.4		8.1	7.2		7.5	6.9		6.8	6.5	105
110	4.9	5.1	5.3	8.2	7.3	6.2	8	7.1	6.1	7.5	6.8		6.7	6.4	110
115	4.7	4.8	5.1	8.1	7.1	6.2	7.8	7	6.1	7.5	6.7	5.9	6.5	6.3	115
120	4.5	4.6	4.8	7.9	7	6.1	7.6	6.8	6	7.4	6.6	5.9	6.4	6.2	120
125	4.3	4.4	4.6	7.6	6.9	6.1	7.4	6.7	6	7.2	6.5	5.8	6.3	6	125
130	4	4.2	4.4	7.4	6.7	6	7.2	6.6	5.9	7	6.4	5.8	6.2	5.9	130
135	3.8	4	4.2	7.1	6.5	6	7	6.4	5.9	6.8	6.3	5.8	6.1	5.7	135
140	3.5	3.8	4.1	6.9	6.3	5.9	6.8	6.3	5.8	6.7	6.2	5.7	5.9	5.6	140
145	3.2	3.6		6.6	6.1	5.8	6.6	6.1	5.8	6.5	6	5.6	5.8	5.5	145
150	2.9	3.2		6.4	5.9	5.6	6.4	5.9	5.6	6.3	5.9	5.6	5.7	5.3	150
155				6.2	5.7	5.5	6.2	5.7	5.5	6.2	5.7	5.5	5.5	5.2	155
160				6	5.5	5.3	6	5.6	5.4	6	5.6	5.4	5.4	5.1	160
165				5.8	5.4	5.2	5.9	5.4	5.3	5.8	5.4	5.3	5.3	5	165
170				5.6	5.2	5.1	5.7	5.3	5.1	5.7	5.3	5.1	5.1	4.8	170
175				5.4	5.1	5	5.5	5.2	5	5.6	5.2	5	5	4.7	175
180				5.3	5	4.9	5.4	5	4.9	5.4	5	4.9	4.9	4.6	180
185				5.1	4.8	4.8	5.2	4.9	4.8	5.3	4.9	4.8	4.8	4.5	185
190				5	4.7	4.7	5.1	4.8	4.7	5.1	4.8	4.7	4.7	4.4	190
195				4.8	4.6	4.6	4.9	4.7	4.6	5	4.7	4.6	4.6	4.4	195
200				4.7	4.5	4.5	4.8	4.6	4.6	4.9	4.6	4.6	4.5	4.3	200
205				4.6	4.4	4.4	4.7	4.5	4.5	4.8	4.5	4.5	4.4	4.2	205
210				4.5	4.3	4.3	4.6	4.3	4.4	4.7	4.4	4.4	4.3	4.1	210
215				4.3	4.2	4.2	4.5	4.3	4.3	4.6	4.3	4.3	4.2	4	215
220				4.2	4.1	4.2	4.4	4.2	4.2	4.5	4.2	4.3	4	4	220
225				4.1	4	4.1	4.3	4.1	4.2	4.4	4.2	4.2	3.8	3.9	225
230				3.9	3.9	4	4.1	4.1	4.1	4.2	4.1	4.2	3.5	3.8	230
235				3.7	3.9	3.9	4.1	4	4.1	4.1	4	4.1	3.2	3.8	235
240				3.6	3.8	3.8	3.9	3.9	4	3.8	4	4.1	3	3.6	240
245				3.4	3.6		3.8	3.8	3.9	3.4	3.9	4	2.7	3.4	245
250				3.2	3.4		3.6	3.8		3.1	3.8	3.9		3.1	250
255				3.1	3.2		3.5	3.6		2.8	3.5	3.7		2.8	255
260							3.3	3.5		2.5	3.1	3.3		2.5	260
265							3.2	3.3			2.8				265
I	0			0			46			92			100	I	
II	0			92			92			92			100	II	
III	0			92			92			92			100	III	
IV	0			92			92			92			100	IV	
V	0			92			92			92			100	V	

\* three-parted folding jib / fléchette pliante à 3 éléments

TAB 133024 / 133025 / 133026



# Lifting heights. Hauteurs de levage.

LTM 1200/1

Folding jib.  
Fléchette pliante.

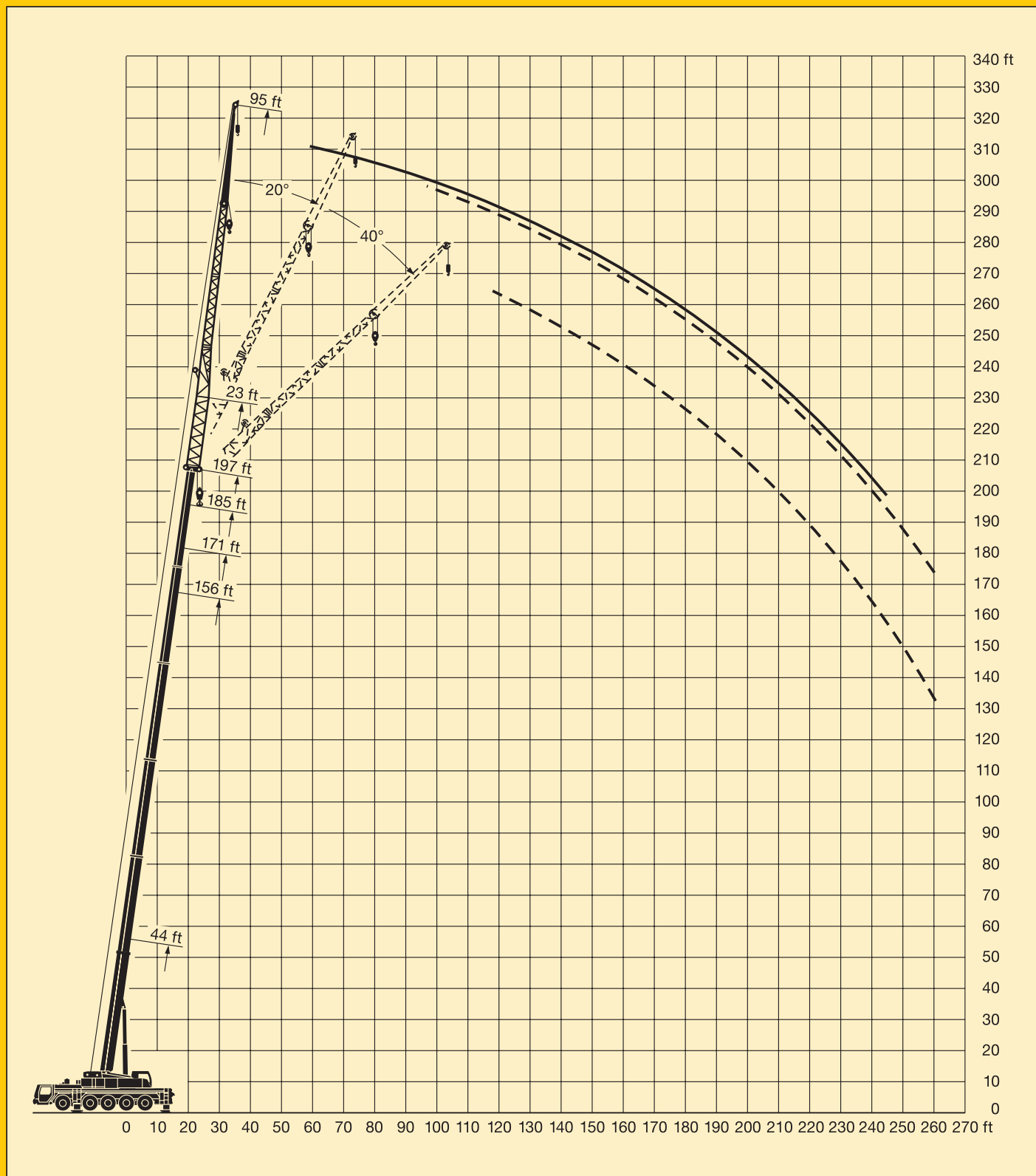



LTM 1200/1

# Lifting capacities on the folding jib with boom extension.

## Forces de levage à la fléchette pliante avec télescope rallongé.



44 ft – 185 ft



23 ft

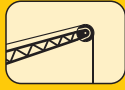

118 ft\*



360°



152100 lbs

85%

ft	44 ft + 23 ft			156 ft + 23 ft			171 ft + 23 ft			185 ft + 23 ft			ft
	118 ft			118 ft			118 ft			118 ft			
	0°	20°	40°	0°	20°	40°	0°	20°	40°	0°	20°	40°	
22	6.3												22
24	6.3												24
26	6.3												26
28	6.3												28
30	6.3												30
32	6.3												32
34	6.3												34
36	6.3												36
38	6.3												38
40	6.2												40
45	6.1												45
50	6.1			6.1									50
55	5.9			6.1									55
60	5.7			6.1			5.6						60
65	5.6	5.3		6.1			5.6			5.1			65
70	5.4	5.2		6.1			5.6			5.1			70
75	5.3	5		6.1			5.6			5.1			75
80	5.1	4.8		6.1			5.6			5.1			80
85	4.9	4.7		6.1			5.6			5.1			85
90	4.7	4.5		6			5.6			5.1			90
95	4.6	4.4		5.9			5.6			5.1			95
100	4.4	4.3	3.9	5.8	5.1		5.6			5.1			100
105	4.3	4.1	3.8	5.7	5		5.5	4.9		5.1			105
110	4.1	4	3.7	5.6	4.9		5.4	4.8		5.1	4.4		110
115	4	3.9	3.6	5.5	4.8		5.3	4.7		5	4.4		115
120	3.8	3.7	3.6	5.4	4.7		5.2	4.6		5	4.4		120
125	3.7	3.6	3.6	5.3	4.6		5.1	4.5		4.9	4.3		125
130	3.5	3.4	3.5	5.2	4.5	3.8	5	4.4	3.6	4.8	4.3		130
135	3.4	3.2	3.4	5.1	4.4	3.8	4.9	4.3	3.6	4.7	4.2	3.6	135
140	3.3	3	3.3	5	4.3	3.8	4.8	4.3	3.6	4.6	4.1	3.6	140
145	3.1	2.9	3.1	4.8	4.3	3.7	4.8	4.2	3.6	4.6	4.1	3.6	145
150	3	2.7	2.9	4.7	4.2	3.7	4.7	4.1	3.6	4.5	4	3.5	150
155	2.9	2.7	2.8	4.7	4.1	3.6	4.6	4.1	3.6	4.4	3.9	3.5	155
160	2.8	2.6	2.7	4.6	4.1	3.6	4.5	4	3.5	4.4	3.9	3.4	160
165	2.7	2.6		4.4	4	3.6	4.4	3.9	3.5	4.3	3.8	3.4	165
170	2.6	2.5		4.3	3.9	3.6	4.3	3.9	3.5	4.2	3.8	3.4	170
175				4.2	3.9	3.6	4.2	3.8	3.5	4.1	3.7	3.4	175
180				4	3.8	3.5	4.1	3.8	3.5	4.1	3.7	3.4	180
185				3.9	3.6	3.5	4	3.7	3.5	4	3.6	3.4	185
190				3.8	3.5	3.4	3.8	3.6	3.4	3.9	3.6	3.4	190
195				3.6	3.4	3.4	3.7	3.5	3.4	3.8	3.5	3.4	195
200				3.5	3.3	3.3	3.6	3.4	3.3	3.6	3.4	3.3	200
205				3.4	3.2	3.2	3.5	3.3	3.2	3.5	3.3	3.2	205
210				3.3	3.1	3.1	3.4	3.2	3.2	3.4	3.2	3.2	210
215				3.2	3	3	3.3	3.1	3.1	3.3	3.1	3.1	215
220				3.1	2.9	2.9	3.2	3	3	3.2	3.1	3	220
225				3	2.9	2.9	3.1	2.9	2.9	3.2	3	3	225
230				2.9	2.8	2.8	3	2.9	2.9	3.1	2.9	2.9	230
235				2.8	2.7	2.8	2.9	2.8	2.8	3	2.8	2.8	235
240				2.8	2.6	2.7	2.8	2.7	2.7	2.9	2.7	2.8	240
245				2.7	2.6	2.7	2.8	2.6	2.7	2.8	2.7	2.7	245
250				2.6	2.5	2.7	2.7	2.6	2.6	2.7	2.6	2.7	250
255				2.5	2.5	2.7	2.6	2.5	2.6	2.6	2.6	2.7	255
260					2.4	2.6	2.5	2.5	2.6	2.5	2.5	2.6	260
265								2.4	2.5		2.5	2.6	265
270								2.4	2.5			2.6	270
275								2.3	2.5			2.4	275
I	0			0			46			92			I
II	0			92			92			92			II
III	0			92			92			92			III
IV	0			92			92			92			IV
V	0			92			92			92			V

\* four-parted folding jib / fléchette pliante à 4 éléments

TAB 133024 / 133025 / 133026



# Lifting heights. Hauteurs de levage.

LTM 1200/1

Folding jib.  
Fléchette pliante.

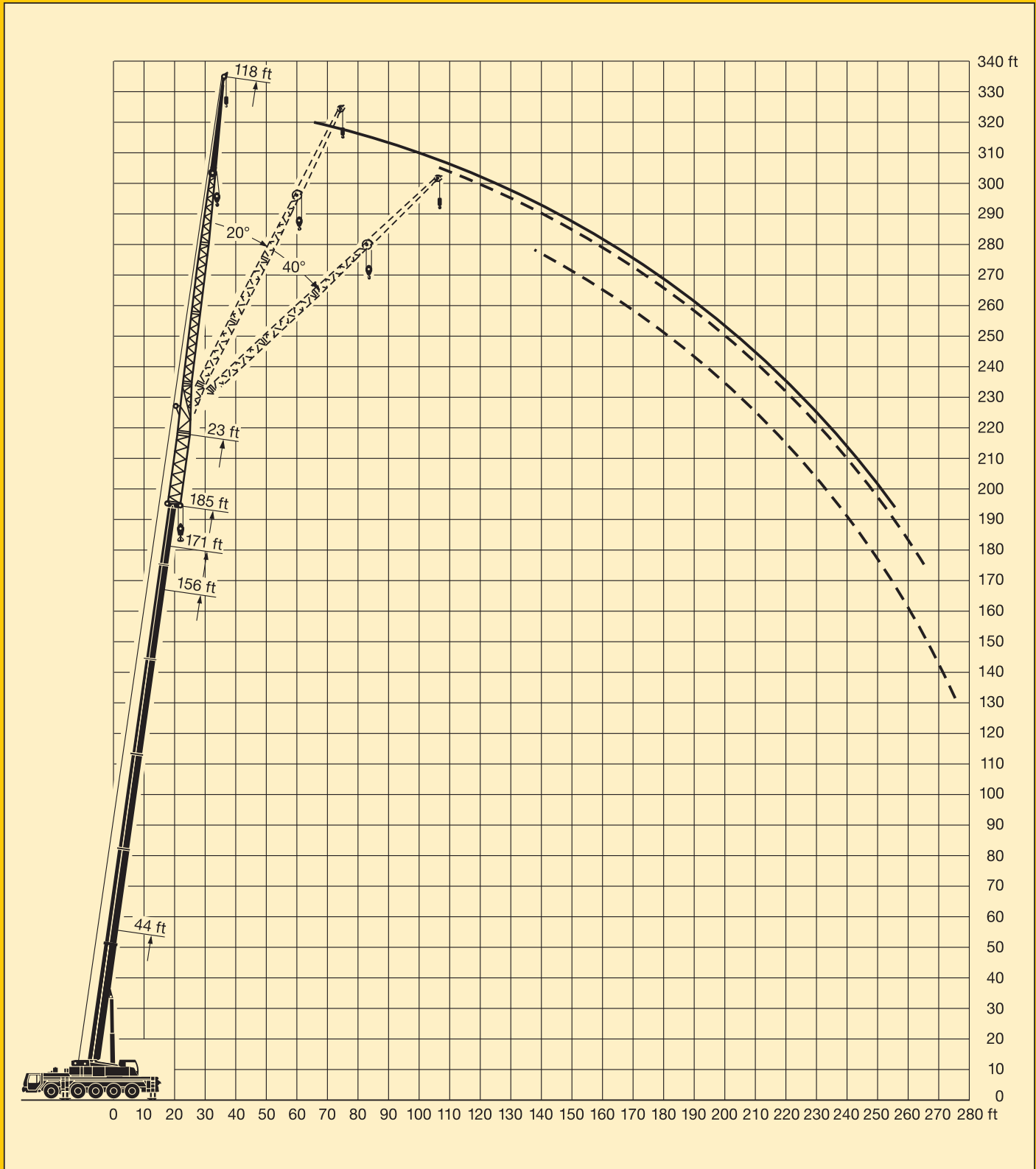



# Dimensions. Encombrement.

LTM 1200/1

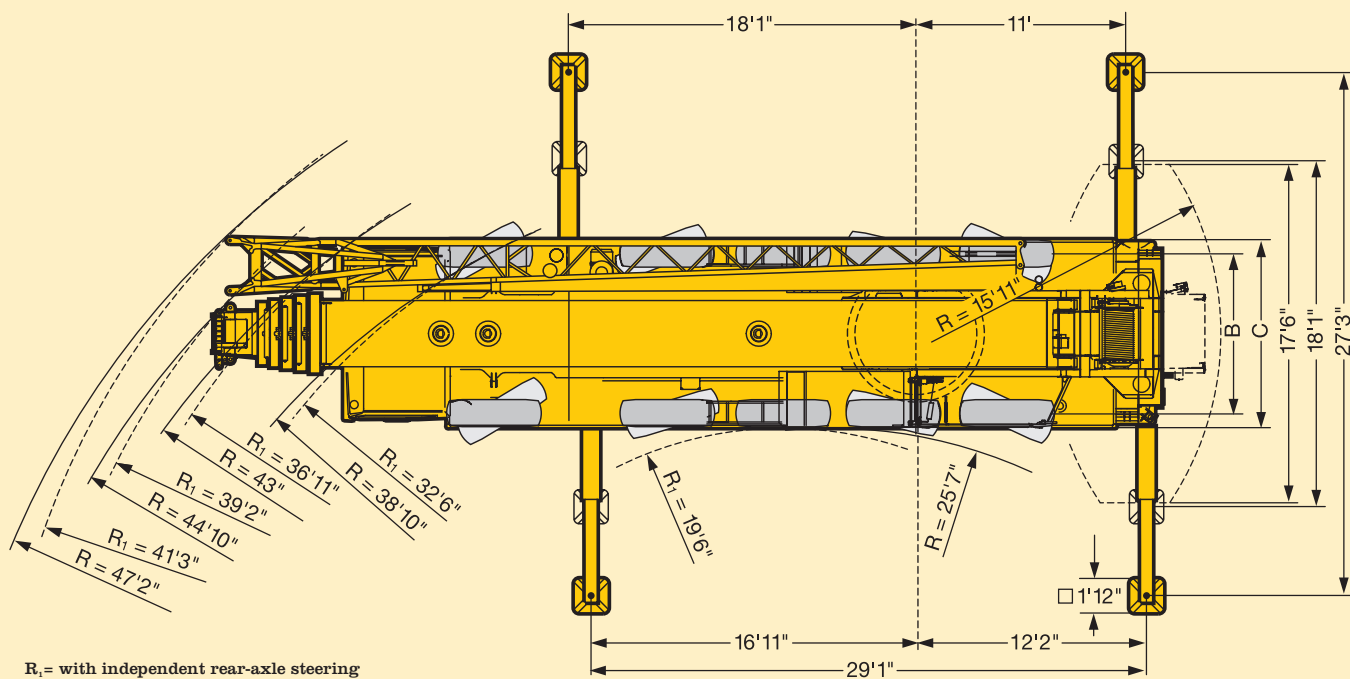
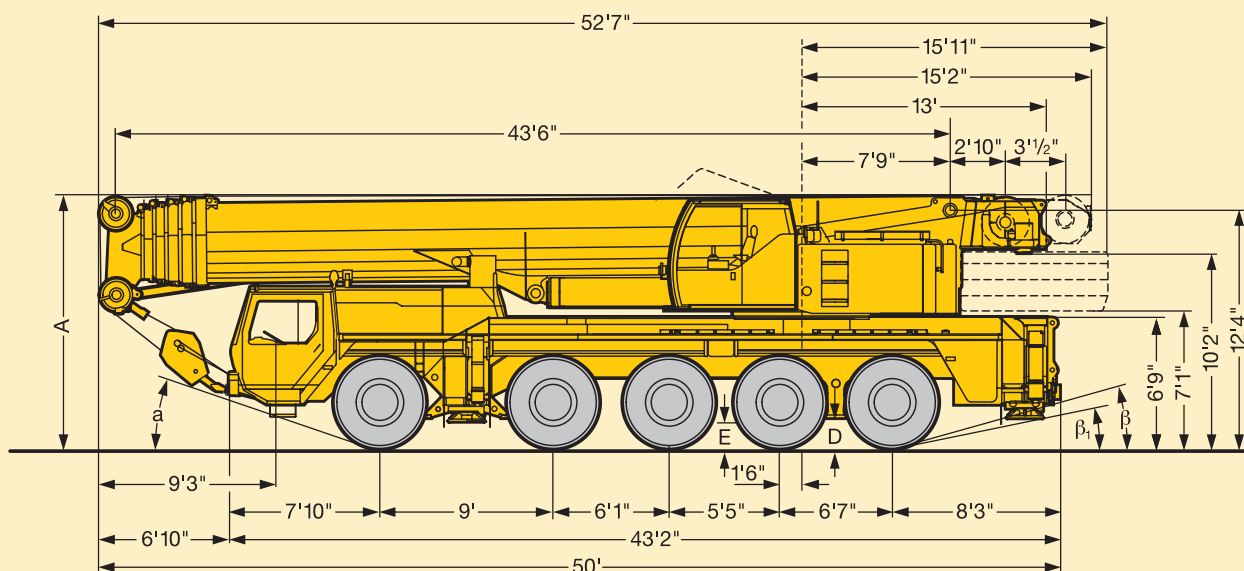

R<sub>1</sub> = with independent rear-axle steering  
à direction essieu arrière indépendante

16.00 R 25	Dimensions / Encombrement							α	β	B <sub>1</sub>
	A	A*	B	C	D	E				
	13'1"	12'3"	8'4"	9'10"	1'4"	1'3"	21°	17°	13°	

\* lowered / abaissé





# Weights. Poids.

LTM 1200/1







Axle Essieu	1	2	3	4	5	Total weight Poids total
lbs	26400	26400	26400	26400	26400	132000







Load kips Forces de levage kips	No. of sheaves Poulies	No. of lines Brins	Weight lbs Poids lbs
385	9	18	528/4400
315	7	14	3740
238	5	11	3190
156	3	7	2290
68	1	3	1910
22	-	1	1100

# Working speeds. Vitesses.



	1	2	3	4	5	6	7	8	9	10	11	12	13	14	15	16	R <sub>1</sub>	R <sub>2</sub>	 %
 16.00 R 25 	3.1	3.7	4.6	5.5	6.7	8.1	9.5	11.5	14.1	17	21	25	30	37	44	50	3.3	4	60 %



Drive Mécanismes	infinitely variable en continu	Rope diameter / Rope length Diamètre du câble / Longueur du câble	Max. single line pull Effort au brin maxi.
	0 - 443 ft/min single line ft/min au brin simple	7/8" / 918'	23470 lbs
	0 - 443 ft/min single line ft/min au brin simple	7/8" / 918'	23470 lbs
	0 - 1,6 rpm		
	approx. 85 seconds to reach 82° boom angle env. 85 s jusqu'à 82°		
	approx. 340 seconds for boom extension from 44 ft - 197 ft env. 340 s pour passer de 44 ft - 197 ft		

**LTM 1200/1**

## Crane Carrier.

<b>Frame:</b>	Self-manufactured, weight-optimized and torsion resistant box-type design of high-tensile structural steel.
<b>Outriggers:</b>	4-point supporting system, hydraulically telescopable into horizontal and vertical direction. Automatic levelling of crane. Electronic inclination indicator.
<b>Engine:</b>	8-cylinder Diesel, make Liebherr, type D 9408 TI-E, watercooled, output 440 kW (589 h.p.) at 2000 min <sup>-1</sup> acc. to ECE-R 24.03 and ECE-R 49.02 (EURO III), max. torque 1836 lbs/ft at 1300 min <sup>-1</sup> . Fuel reservoir: 127 gallons.
<b>Transmission:</b>	ZF 16-speed gear box with automatic control system AS-TRONIC. ZF-intarder fitted directly to the gear. Single-stage transfer case with lockable transfer differential.
<b>Axles:</b>	Welded design, made of high-tensile fine grained steel. Axles 1, 2, 4 and 5 steerable. Axles 1, 4 and 5 are planetary axles with differential locks.
<b>Suspension:</b>	All axles are mounted on hydropneumatic suspension - "Niveaumatik suspension" and are lockable hydraulically.
<b>Tyres:</b>	10 tyres, size: 16.00 R 25.
<b>Steering:</b>	ZF semi-integral power steering, dual circuit system with hydraulic servo-system and additional backing pump driven by an axle. Steering acc. to EG directive 70/311/EWG.
<b>Brakes:</b>	Service brake: Dual circuit, all-wheel servo-air brake. Parking brake: Spring brake actuator, acting on the wheels of the 2nd and 5th axle. Sustained-action brakes: Engine brake as exhaust retarder with Liebherr additional brake system ZBS. Intarder on gear. Brakes acc. to EG directives 71/320 EWG.
<b>Driver's cab:</b>	Spacious, steel made, corrosion resistant cab, cataphoretic dip-primed, on resilient suspension with hydraulic shock absorbers, sound and heat absorbing internal panelling acc. to EG directive, safety glazing, operating and control instruments, comfortably equipped.
<b>Electr. system:</b>	Modern data bus technique, 24 Volt DC, 2 batteries of 170 Ah each, lighting acc. to traffic regulations.

## Crane superstructure.

<b>Frame:</b>	Self-manufactured, weight-optimized and torsion resistant welded design of high-tensile structural steel; linked by a triple-row roller slewing rim to the carrier for continuous rotation.
<b>Crane engine:</b>	4-cylinder Diesel, make Liebherr, type D 924 TI-E, watercooled, output 180 kW (245 h.p.) at 1800 min <sup>-1</sup> acc. to EPA/CARB and stage 2 acc. to directive 97/68 EG, max. torque 796 lbs/ft at 1150 min <sup>-1</sup> , fuel reservoir: 66 gallons.
<b>Crane drive:</b>	Diesel-hydraulic, with 5 axial piston variable displacement pumps, with servo-control and capacity control, 1 double gear pump. Compact hydraulic drive flanged to the Diesel engine. Drive assembly completely enclosed for noise abatement.
<b>Control:</b>	Electronic control by the LICCON computer system (PLC control), two self-centering control levers (joy-sticks). Pedal switches for telescoping. Infinitely variable crane motions through displacement control of the hydraulic pump. Additional working speed control by variation of the Diesel engine.
<b>Hoist gear:</b>	Axial piston variable displacement motor, Liebherr hoist drum with integrated planetary gear and spring-loaded static brake. Actuation by closed regulated oil circuit.
<b>Luffing gear:</b>	1 differential ram with nonreturn valve.
<b>Slewing gear:</b>	Axial piston fixed displacement motor, planetary gear, spring-loaded static brake.
<b>Crane cab:</b>	All-steel construction, entirely galvanized, powder coated, with safety glazing, operating and control instruments, comfortably equipped, cab tiltable backwards.
<b>Safety devices:</b>	LICCON safe load indicator, test system, hoist limit switch, safety valves to prevent pipe and hose ruptures.
<b>Telescopic boom:</b>	Buckling and torsion resistant design of high-tensile structural steel, oviform boom profile, 1 base section and 5 telescopic sections. All telescopic sections hydraulically extendable independent of one another. Rapid-cycle telescoping system "Telematik". Boom length: 44 ft - 197 ft.
<b>Counterweight:</b>	152100 lbs.
<b>Electr. system:</b>	Modern data bus technique, 24 Volt DC, 2 batteries of 170 Ah each.

## Optional equipment.

<b>Swing-away jib:</b>	40 ft - 118 ft long, mountable to the telescopic boom at 0°, 20° or 40°.
<b>Telescopic boom extension:</b>	23 ft long lattice section, thus 23 ft higher pinning point for swing-away jib.
<b>2nd hoist gear:</b>	For two-hook operation or for operation with swing-away jib if the hoist rope shall remain reeved.
<b>Drive 10 x 8:</b>	Additional drive of the 2nd axle.
<b>Further items available on request.</b>	



## Châssis porteur.

**LTM 1200/1**

<b>Cadre:</b>	Construction en caisse résistante à la torsion et optimisée en poids réalisée par Liebherr en acier de construction à grain fin très rigide.
<b>Calage:</b>	Dispositif de calage horizontal et vertical en 4 points, entièrement déployable hydrauliquement. Nivellement automatique du calage. Indicateurs électroniques d'inclinaison.
<b>Moteur:</b>	Moteur Diesel, 8 cylindres, fabriqué par Liebherr, type D 9408 TI-E, refroidi à l'eau, puissance 440 kW (589 ch) à 2000 min <sup>-1</sup> suivant ECE-R 24.03 et ECE-R 49.02 (EURO III), couple maxi 1836 lbs/ft à 1300 min <sup>-1</sup> . Réservoir de carburant: 127 gallons.
<b>Boîte de vitesses:</b>	Boîte de vitesses ZF à 16 rapports, mécanisme automatisé à commande AS-TRONIC. Ralentisseur hydrodynamique ZF directement accouplé à la boîte. Boîte de transfert à un étage avec blocage de différentiel.
<b>Essieux:</b>	Construction soudée en acier à haute résistance fins grains. Essieux 1, 2, 4 et 5 directeurs. Essieux 1,4 et 5 planétaires avec blocage différentiel.
<b>Suspension:</b>	Suspension hydropneumatique "Niveaumatik" - sur tous les essieux. Chaque essieu peut être bloqué hydrauliquement.
<b>Pneumatiques:</b>	10 pneus de taille: 16.00 R 25.
<b>Direction:</b>	Direction semi-bloc ZF, à double circuit, assisté hydrauliquement, avec pompe auxiliaire entraînée par un essieu. Direction conforme aux directives européennes 70/311/CE.
<b>Freins:</b>	Freins de service: servofrein à air comprimé, à 2 circuits. Frein à main: ressort accumulé agissant sur les roues des essieux 2 à 5. Freins continus: frein moteur par clapet sur échappement avec système de ralentissement Liebherr ZBS. Ralentisseur hydrodynamique accouplé à la boîte de vitesses. Freins conformes aux directives européennes 71/320 CE.
<b>Cabine du conducteur:</b>	Cabine spacieuse en tôle d'acier traitement anti-corrosion par bain de cataphorèse, avec suspension élastique et amortisseurs hydrauliques, revêtement intérieur avec isolation phonique et thermique selon les directives européennes, glaces de sécurité, appareils de commande et de contrôle, équipement confortable.
<b>Installation électrique:</b>	Technique moderne de transmission de données par BUS de données, courant continu 24 Volts, 2 batteries de 170 Ah chacune, éclairage conforme au code de la route.

## Partie tournante.

<b>Cadre:</b>	Construction soudée résistante à la torsion et optimisée en poids réalisée par Liebherr en acier de construction à grain fin très rigide. Couronne d'orientation à rouleaux à 3 rangées permettant une rotation illimitée sert de pièce de liaison avec le châssis de la grue.
<b>Moteur:</b>	Moteur Diesel, 4 cylindres, fabriqué par Liebherr, type D 924 TI-E, refroidi à l'eau, puissance 180 kW (245 PS) à 1800 min <sup>-1</sup> selon EPA/CARB et étage 2 selon les directives 97/68 CE, couple maxi 796 lbs/ft à 1150 min <sup>-1</sup> , réservoir de carburant: 66 gallons.
<b>Entraînement de la grue:</b>	Diesel hydraulique avec 5 pompes à débit variable à pistons axiaux, servocommande et régulation de la puissance, 1 double pompe à engrenages. Entraînement hydraulique compact, accouplé directement au moteur Diesel, mécanisme d'entraînement total fermé pour une bonne insonorisation.
<b>Commande:</b>	Commande électronique par l'ordinateur LICCON (commande SPS). 2 leviers à 4 directions avec rappel automatique au point mort. Commande des mouvements progressive en continu par variation de l'inclinaison des pompes et augmentation du régime moteur.
<b>Mécanisme de levage:</b>	Moteur hydraulique à cylindrée variable, treuil de marque Liebherr avec réducteur planétaire à frein d'arrêt à lamelles intégrées, en circuit hydraulique fermé.
<b>Mécanisme de relevage:</b>	1 vérin hydraulique différentiel avec clapets anti-retour de sécurité.
<b>Dispositif de rotation:</b>	Moteur à cylindrée constante à pistons axiaux, engrenage planétaire, frein d'arrêt commandé par ressort.
<b>Cabine du grutier:</b>	Construction en tôle d'acier entièrement zinguée avec peinture par poudrage et cuisson au four, avec glaces de sécurité, appareils de commande et de contrôle, équipement confortable. Cabine inclinable vers l'arrière.
<b>Dispositif de sécurité:</b>	Contrôleur de charge "LICCON", système test, limitation de la course pour le levage, soupape de sûreté contre la rupture de tubes et de tuyaux.
<b>Flèche télescopique:</b>	Flèche télescopique en acier à haute résistance à grains fins, à profil ovale, 1 élément de base et 5 éléments télescopiques. Tous les éléments télescopables indépendamment les uns des autres. Système de télescopage séquentiel rapide "Telematik". Longueur de flèche: 44 ft - 197 ft.
<b>Contrepoids:</b>	152100 lbs.
<b>Installation électrique:</b>	Technique moderne de transmission de données. Courant continu 24 Volts, 2 batteries de 170 Ah chacune.

## Équipement supplémentaire.

<b>Fléchette pliante:</b>	Longueur: 40 ft - 118 ft, montable sous un angle de 0°, 20° ou 40°.
<b>Rallonge flèche télescopique:</b>	Élément en treillis de 23 ft, de cette manière point d'articulation plus haute de 23 ft pour la flèche pliante.
<b>2ème mécanisme de levage:</b>	Pour l'utilisation du deuxième crochet, ou bien pour une utilisation avec fléchette pliante lorsque le câble de levage principal rest mouflé.
<b>Entraînement 10 x 8:</b>	Essieu 2 est entraîné additionnellement.
<b>Autres équipements supplémentaires sur demande.</b>	



Subject to modification. / Sous réserve de modifications.

TP 305. US.10.00

**Please contact**

**Veuillez prendre contact avec**

**LIEBHERR-WERK EHINGEN GMBH**

**D-89582 Ehingen/Donau, Telefon (0 73 91) 5 02-0, Telefax (0 73 91) 5 02-33 99**

**[www.lwe.liebherr.de](http://www.lwe.liebherr.de), E-mail: [info@lwe.liebherr.com](mailto:info@lwe.liebherr.com)**

CD-